

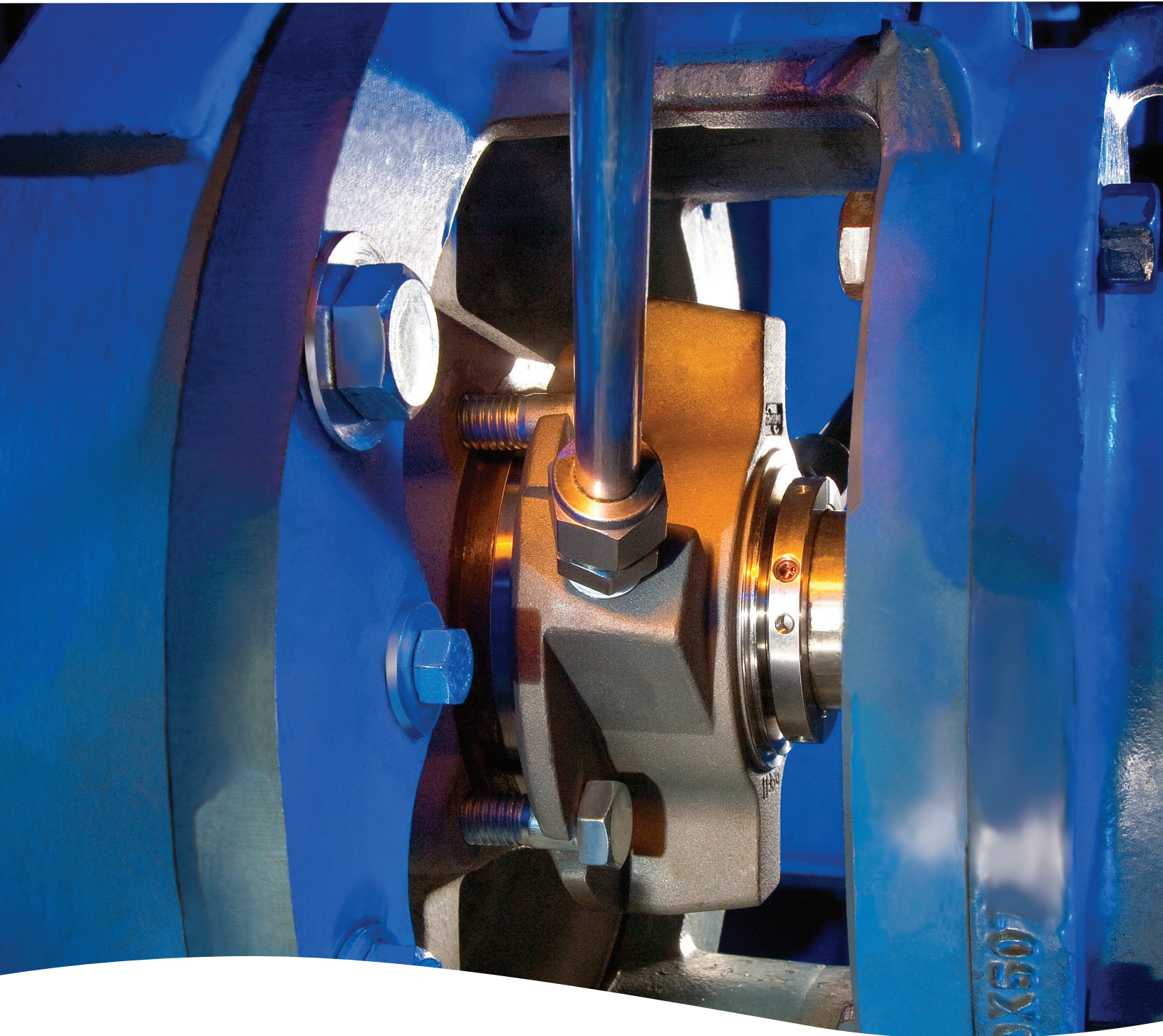

SEAL PRODUCT PORTFOLIO



Experience In Motion



TABLE OF CONTENTS

Experience In Motion 4

**Advanced Sealing Solutions for
the Most Demanding Environments** 7

Industries 8

Services 10

Other Flowserve Products 12

When and Where You Need Us 13

Standard Cartridge

Quick Reference Chart 17

Industrial Process 18

API Process 18

Mixer Equipment 18

Pusher

Quick Reference Chart 21

Industrial Process 23

API Process 26

Pusher 27

Metal Bellows

Quick Reference Chart 29

Industrial Process 30

API Process 31

Mixer

Quick Reference Chart 35

Mixer & Specialty Equipment 36

Mixer Equipment 37

Compressor Seals and Systems

Quick Reference Chart 39

Gas Compressor Process 40

Gas Support System 41

Slurry

Quick Reference Chart 45
Slurry Process 46

Gas Barrier and Containment

Quick Reference Chart 49
Industrial Process 50
API Process 50

OEM and Special Duty

Quick Reference Chart 53
Industrial Process 54
High-Viscosity Process 55
Steam Turbines 55
Specialty Equipment 55

Seal Support Systems

Quick Reference Chart 59
Industrial & API Process 60

Accessories

Quick Reference Chart 65
Bearing Isolator 66
Industrial Process 66
High-Energy Process 67
Slurry Process 68

Appendix

Basic Design and Operation 72
Design Options 75
Seal Materials 78
Mechanical Seal Piping Plans 80

Index 84





EXPERIENCE IN MOTION

Every day, our customers are challenged to take their plant operations to the next level. To do that, they need partners who deliver much more than products.

Flowserve is answering that call. We're working with the world's most important providers of oil and gas, power, chemicals, water and other essential products to solve the absolute toughest challenges in fluid motion and control.

Our industry-leading portfolio of pumps, seals, valves and actuation is only part of the story. Our customers need answers that demand extensive know-how and experience, and we've got it. More than 18 000 committed associates are go-to resources for expert engineering, project management, technical support and service in every corner of the world.



Expertise and Experience

Flowserve has an unrivaled combination of technical expertise and practical experience to help you solve the toughest fluid motion control challenges.

Proven Quality and Reliability

Flowserve products are designed for maximum safety and reliability — all to help you reduce unplanned downtime while keeping workers and plant assets safe.

Comprehensive Portfolio

Flowserve offers the world's most complete portfolio of pumps, seals, valves and actuation. As a result, you'll get the best solution with minimal time shopping and evaluating.

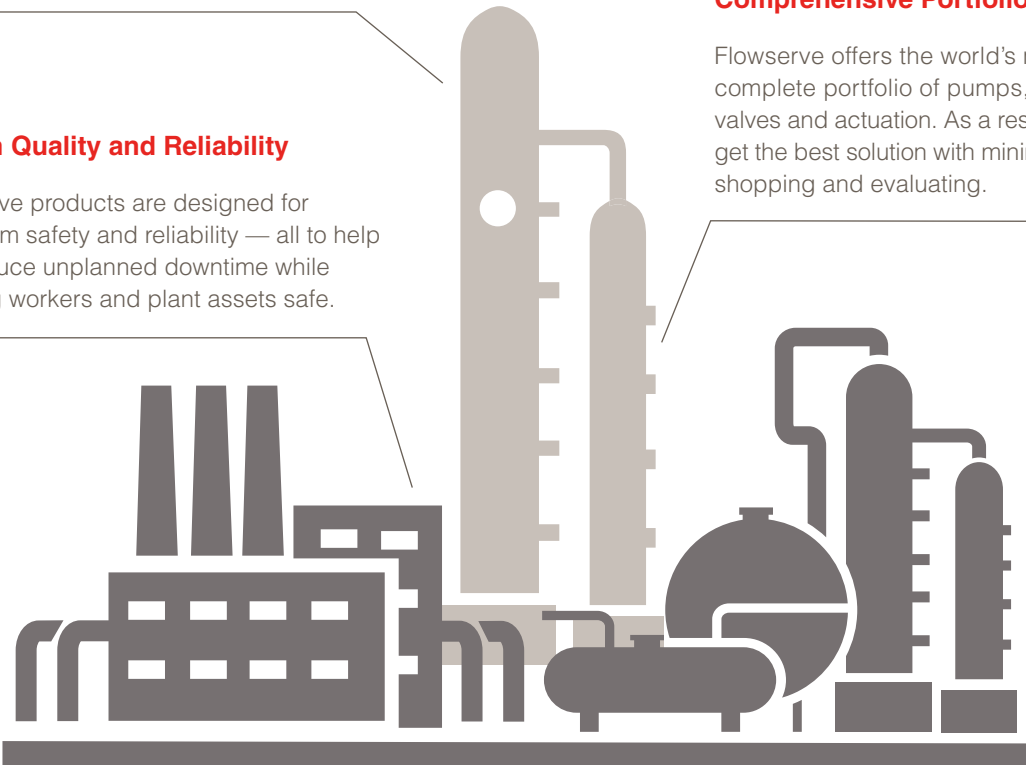

Technology and Insights

We help maximize your systems' efficiency and uptime by applying flow-specific technologies and advanced aftermarket capabilities, all supported by a vast team of technical resources.

Local Support Worldwide

Flowserve is everywhere you do business. Our global network of Quick Response Centers helps to minimize downtime with hands-on support that's fast and dependable.



ADVANCED SEALING SOLUTIONS FOR THE MOST DEMANDING ENVIRONMENTS

The applications just keep getting tougher. Higher pressures and temperatures. More corrosive and erosive fluids. So, Flowserve continues to redefine the way mechanical seals operate by developing some of the most advanced seal modeling, design and manufacturing capabilities in the world. These pioneering techniques have led to sophisticated seal face topographies and innovative microfeatures that can be designed to boost your bottom line by enhancing fluid film, creating lift, reducing friction, minimizing emissions and reducing wear.

All of this makes Flowserve seals the industry's top choice for the most demanding environments. The success of your application isn't just about seal design. It also depends on selecting the right model, design options, materials, arrangements and piping plans. Flowserve engineers make sure you have the most appropriate seal and sealing system to ensure high reliability, long life and low total cost of ownership.



INDUSTRIES

The world's infrastructure industries rely on Flowserve to solve their most complex fluid motion and control challenges. We deliver more than the most complete portfolio of pumps, seals, valves and actuation; we help our customers exceed their operational goals. We understand that profitable performance requires critical process equipment and systems operate safely, reliably and at maximum efficiency. Our commitment to meeting these expectations for our customers drives everything we do.



OIL AND GAS

From production wells deep on ocean floors and remote oil sands, to transportation infrastructures that span continents and refineries that create the world's feedstocks — global energy companies push the limits of fluid motion and control. They need solutions for increasingly demanding applications. To meet their high-temperature, high-pressure processing needs, Flowserve provides unmatched mechanical, hydraulic and materials know-how and the industry's most complete flow management portfolio. Backed by service and support teams around the globe, we can help maximize uptime, productivity and safety, and keep you at the forefront of innovation.



CHEMICAL

Aggressive corrosion and erosion. Hazardous, toxic substances. Application variation that makes equipment specification more than a little challenging. The chemical industry faces tough challenges, and Flowserve is in the middle of them, solving our customers' most difficult hurdles every day. Our solutions span the industry, from basic, organic, specialty and fine chemicals to biofuels and pharmaceuticals. We continue to build on our materials science heritage and advance sealing and flow control technologies. We do this to help customers improve performance, maximize service life and keep personnel safe.



POWER

Rapid load variations, frequent stops and starts, and the highest temperatures, flows and pressures. Welcome to fluid motion and control in the power industry. These grueling applications are where Flowserve became a driving force in power generation. To appreciate our role, you needn't look further than our pioneering work in nuclear power or the massive machines we've built for conventional steam plants. But that's history. Today, we're developing next generation solutions to meet the newest challenges, including concentrated solar, biomass and geothermal.



WATER RESOURCES

Whether for flood control, desalination, distribution, waste management or agriculture, those who move water need to do it economically, sustainably and reliably. They need low-maintenance equipment and high-efficiency systems that minimize energy consumption. They also need partners who ensure the right solution is specified every time to minimize environmental impacts and control total lifecycle costs. Supplying flow management systems for global water resources is a commitment with far-reaching implications. That's why the world's leading municipalities and water system providers trust Flowserve.

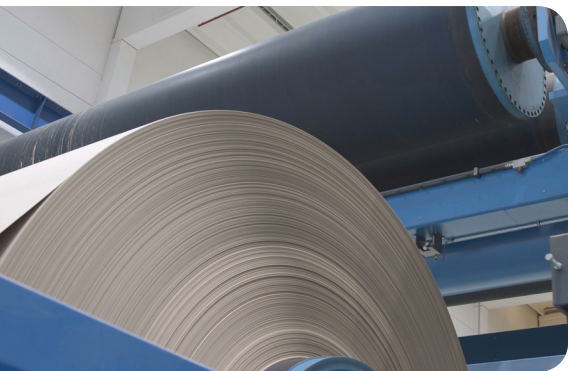

GENERAL INDUSTRY

From paper and metals to sweeteners and electronics, most of the world's products depend on reliable fluid motion and control solutions. Endless demanding and complicated application parameters are found in industries such as food and beverage, mining, steelmaking, and pulp and paper. Flowserve has a global portfolio of solutions and technical expertise capable of tackling the tough and often unique requirements found in these industries. A global network of Quick Response Centers delivers the timely technical support, parts and service needed to keep operations running dependably and profitably.



SERVICES

SERVICES THAT DRIVE SAFETY, RELIABILITY AND PERFORMANCE

Flowserve offers a comprehensive suite of services designed to provide unprecedented value and cost savings throughout the life span of a system. By integrating hydraulic, mechanical and materials engineering knowledge with real-world operating and practical business solutions, Flowserve helps customers:

- Increase equipment reliability
- Optimize asset uptime and performance
- Improve plant and personnel safety
- Lower total cost of maintenance



PARTS, REPAIRS, UPGRADES AND FIELD SERVICES

Investments in well-equipped Quick Response Centers, mobile service fleets, and advanced manufacturing technologies along with the unrivaled expertise of its engineers, technicians and craftsmen enable Flowserve to address virtually every service requirement for process equipment, on- or off-site, regardless of OEM.

- **Repair and Upgrades** — From machining to mechanical upgrades to on-site management, Flowserve repairs and upgrades services improve equipment performance while reducing downtime and costs.
- **Replacement Parts and Components** — Using its broad network of service and manufacturing centers, Flowserve supplies customers with the quality parts needed to keep operations running smoothly and profitably.
- **Field Services** — From maintenance to management, highly qualified Flowserve project managers, engineers and technicians can be deployed on-site to help your operations run smoothly.

ENGINEERING AND TECHNICAL SERVICES

With world-class engineering and technical resources in more than 55 countries, Flowserve delivers value-added solutions that improve operational performance and increase profitability for its customers.

- **Technical Assessments** — Flowserve can perform system audits to identify operational issues that may be constraining output or elevating operating costs and recommended solutions.
- **Reliability Services** — Flowserve offers standard solutions to improve rotating equipment reliability while lowering cost of ownership.
- **Engineering Support** — Flowserve engineers can engage remotely or on-site to support grassroots project planning, system design or project management requirements.



ASSET MANAGEMENT AND OPTIMIZATION

Flowserve continues to invest in capabilities and technologies to help customers realize more payback from their plant assets.

- **LifeCycle Advantage™** — Through a combination of on-site assessments and technology, Flowserve experts help customers benchmark operational performance, define key metrics and implement solutions to achieve their long-term operational goals.
- **Intelligent Performance Solutions** — By employing sophisticated products, services and software to collect, examine and understand data, Flowserve helps customers use predictive analytics to take action and improve asset reliability.

EDUCATION AND TRAINING

Flowserve offers a wide range of innovative programs to help plant operators, reliability specialists, engineers and maintenance personnel deepen their understanding of critical equipment and processes.

- **Learning Resource Centers** — At its state-of-the-art Learning Resource Centers, Flowserve provides hands-on training and instruction in the principles of equipment operation, maintenance and reliability.
- **Customer On-site Training** — Flowserve can design, develop and deliver training programs tailored specifically around the people, equipment and processes at a customer's facility.
- **Online Training** — Flowserve offers web-based modules with online testing and reporting to ensure comprehension of the most important principles.



OTHER FLOWSERVE PRODUCTS

Flowserve has the products, systems and expertise to help processes run smarter, safer and more efficiently. In addition to its extensive seal portfolio, Flowserve offers high-quality pumps, valves and actuation for the world's toughest applications.

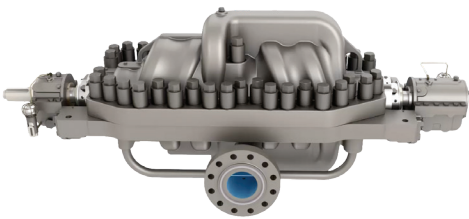

PUMPS

Pumping systems from Flowserve meet customer demands in the most arduous services. Our world-renowned brands of pre-engineered, engineered and special purpose pumps give customers access to the most impressive portfolio of proven hydraulic and mechanical know-how.



VALVES

Flowserve valves are found in the world's toughest industries, where reliable performance is the only option. High temperatures, ultra-high pressures, erosion and corrosion are at the core of the dozens of leading brands that comprise our broad valve portfolio.



ACTUATION & INSTRUMENTATION

From positioners and switches to remotely controlled, fully automated electric, hydraulic and pneumatic actuators, customers depend on the full range of intelligent automation solutions from Flowserve to help their processes run smarter, safer and more efficiently.

WHEN AND WHERE YOU NEED US

Our network of manufacturing facilities, design centers of excellence, strategically located Quick Response Centers and customer on-site resources means customers never have to look far for support.



FLowsERVE

GASPAC

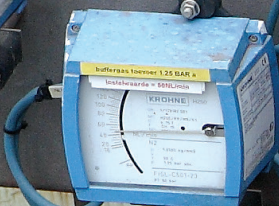

Two workers in blue uniforms and white hard hats are reviewing a document. The document is titled "Model Configuration System" and contains a table with columns for "Parameter", "Value", and "Unit". The worker on the left is pointing at the document, while the worker on the right is pointing at a valve on the equipment.

The worker on the right is wearing large blue earmuffs and is pointing at a valve on the equipment. The equipment is a complex system of pipes, valves, and flowmeters.

SEALS

Standard Cartridge	16
Pusher	20
Metal Bellows	28
Mixer	34
Compressor Seals and Systems	38
Slurry	44
Gas Barrier and Containment	48
OEM and Special Duty	52
Seal Support Systems	58
Accessories	64



ISC2 Series

STANDARD CARTRIDGE

Nonstop operation. Off-design operation. Frequent stops and starts. No matter how hard you run your system, Flowserve ISC2 standard cartridge seals are up to the task. They're versatile enough to support hundreds of pump models from global manufacturers while meeting all international standards (ASME, DIN, ISO, JIS, and others). You'll also keep costs low with easy installation, less inventory, greater flexibility, less downtime and longer service life.

Standard Cartridge – Quick Reference

Product	Sub-Type	Pressures to	Temperatures	Speeds to	Sizes
ISC2	Industrial Process	20.6 bar (300 psi)	-40°C to 204°C (-40°F to 400°F)	23 m/s (75 fps)	25 to 200 mm (1.000 to 8.000 in)
ISC2-682	API Process	20.6 bar (300 psi)	-40°C to 204°C (-40°F to 400°F)	23 m/s (75 fps)	25 to 200 mm (1.000 to 8.000 in)
ISC2-MW	Mixer Equipment	6.9 bar (100 psi)	-40°C to 204°C (-40°F to 400°F)	1.1 m/s (3.5 fps)	25 to 200 mm (1.000 to 8.000 inch)

STANDARD CARTRIDGE

INDUSTRIAL PROCESS

ISC2

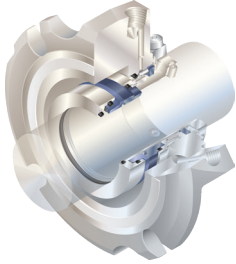

The ISC2 Series provides exceptional reliability and standardization over a wide variety of industrial applications and equipment. Available in single and dual arrangement, pusher and metal bellows types.

- Lower total cost of ownership from advanced seal design features that enable superior reliability
- Broad application flexibility assured by comprehensive range of pre-engineered configurations and materials; custom solutions also available
- Reduced operating costs via standardization to ISC2 Series, which enables less inventory, greater flexibility, less downtime and longer seal life
- Increased plant and personnel safety delivered by cartridge security and compliance with all major international standards

SPECIFICATIONS

Press: pusher to 20.6 bar (300 psi);
bellows to 13.8 bar (200 psi)
Temp: -40°C to 204°C (-40°F to 400°F)
Speeds to: 23 m/s (75 fps)
Sizes: pusher 25 to 200 mm
(1.000 to 8.000 in);
bellows to 95 mm (3.750 in)

Refer to literature FSD243
at flowserve.com/library.

API PROCESS

ISC2-682

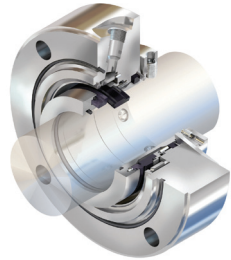

The ISC2-682 Series is the versatile ISC2 family of pusher and metal bellows seals engineered to fully comply with the design and qualification requirements of API 682.

- Compliance with the sealing industry's most comprehensive best practices standard assured by machined from bar stock glands, captured gland O-ring and thick sleeves
- API 682 Category 2 met by adding multiport flush and floating throttle bushing
- Application flexibility assured by designs configurable as either Type A pusher seal or Type B metal bellows seal in Arrangements 1, 2 and 3
- Ideally suited for ASME B73.1 pumps and light-duty API 610 pumps within plants that adopt the API 682 standard

SPECIFICATIONS

Press: pusher to 20.6 bar (300 psi);
bellows to 13.8 bar (200 psi)
Temp: -40°C to 204°C (-40°F to 400°F)
Speeds to: 23 m/s (75 fps)
Sizes: pusher 25 to 200 mm
(1.000 to 8.000 in);
bellows to 95 mm (3.750 in)

Refer to literature FSD237
at flowserve.com/library.

MIXER EQUIPMENT

ISC2-MW

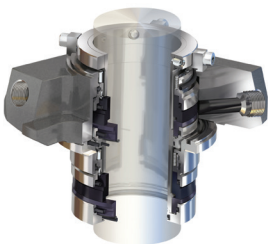

The ISC2-MW is a dual arrangement, standard cartridge pusher seal engineered for reliable, cost-effective operation in mixer service.

- Reduced installation and maintenance costs assured by economical cartridge seal designed for top- entry installation
- Increased uptime resulting from volute groove, which significantly increases barrier fluid flow to promote cool running, even at mixer speeds
- Reliable operation ensured by ISC2 thermal management technology that allows the seal to run cooler and tolerate dry-running events

SPECIFICATIONS

Press. to: 6.9 bar (100 psi)
Temp: -40°C to 204°C (-40°F to 400°F)
Speeds to: 1.1 m/s (3.5 fps)
Sizes: 25 to 200 mm
(1.000 to 8.000 inch)

Refer to literature FSD104
at flowserve.com/library.

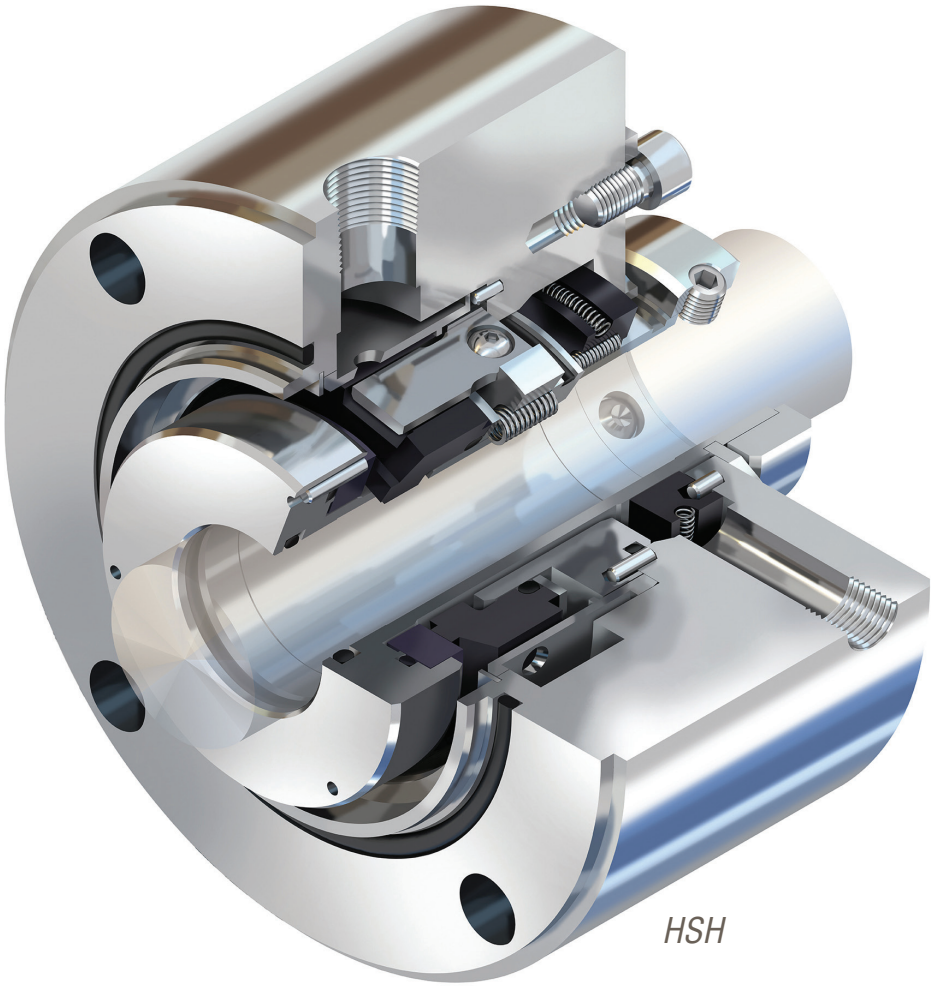

HSH

PUSHER

Popular for their cost-effective versatility, you'll find Flowserve pusher seals in a wide variety of applications and industries. From general services and light hydrocarbons to high-pressure and high-speed applications, Flowserve pusher seals provide the extended reliability and rugged durability you can count on. Even after years of operation, Flowserve pusher seals have a proven reputation for easy repairs that return them to service quickly.

Pusher – Quick Reference*

Product	Sub-Type	Pressures to	Temperatures	Speeds to	Sizes
ISC2-PX, ISC2-XP, ISC2-682PX and ISC2-682XP	Industrial Process	20.6 bar (300 psi)	-40°C to 204°C (-40°F to 400°F)	23 m/s (75 fps)	25 to 200 mm (1.000 to 8.000 in)
ISC2-PP and ISC2-682PP	Industrial Process	20.6 bar (300 psi)	-40°C to 204°C (-40°F to 400°F)	23 m/s (75 fps)	25 to 200 mm (1.000 to 8.000 in)
QB, QBS and QBU	Industrial Process	51.7 bar (750 psi)	-40°C to 204°C (-40°F to 400°F)	23 m/s (75 fps)	12.7 to 139.7 mm (0.500 to 5.500 in)
UC and UCQ	Industrial Process	27.6 bar (400 psi)	-40°C to 204°C (-40°F to 400°F)	23 m/s (75 fps)	14.1 to 148 mm (0.566 to 5.838 in)
RO	Industrial Process	20.7 bar (300 psi)	-40°C to 260°C (-40°F to 500°F)	23 m/s (75 fps)	9.5 to 115 mm (0.375 to 4.500 in)
CRO	Industrial Process	20.7 bar (300 psi)	-40°C to 260°C (-40°F to 500°F)	23 m/s (75 fps)	9.5 to 115 mm (0.375 to 4.500 in)
Europac Series	Industrial Process	25 bar (360 psi)	-40°C to 220°C (-40°F to 430°F)	23 m/s (75 fps)	10 to 100 mm (0.394 to 3.940 in)
RA and RA-C	Industrial Process	27.6 bar (400 psi)	-40°C to 177°C (-40°F to 350°F)	23 m/s (75 fps)	13 to 127 mm (0.500 to 5.000 in)

* Additional products shown on next page

Pusher – Quick Reference, cont'd.

Product	Sub-Type	Pressures to	Temperatures	Speeds to	Sizes
QBQ and QBQ LZ	API Process	51.7 bar (750 psi)	-40°C to 204°C (-40°F to 400°F)	23 m/s (75 fps)	12.7 to 139.7 mm (0.500 to 5.500 in)
QBB and QB2B	API Process	51.7 bar (750 psi)	-40°C to 204°C (-40°F to 400°F)	23 m/s (75 fps)	20 to 121 mm (0.787 to 4.750 in)
HSH	API Process	103 bar (1500 psi)	-40°C to 260°C (-40°F to 500°F)	46 m/s (150 fps)	25.4 to 156 mm (1.000 to 6.125 in)
UO and UOP	Pipeline Process	103.4 bar (1500 psi)	-40°C to 204°C (-40°F to 400°F)	23 m/s (75 fps)	14.1 to 148 mm (0.566 to 5.838 in)
D and DP	High-Energy Process	103.4 bar (1500 psi)	-73°C to 343°C (-100°F to 650°F)	23 m/s (75 fps)	13.4 to 137 mm (0.525 to 5.400 in)
UHTW and DHTW	High-Energy Process	207 bar (3000 psi)	-40°C to 371°C (-40°F to 700°F)	76 m/s (250 fps)	25.4 to 228.6 mm (1.000 to 9.000 in)

INDUSTRIAL PROCESS

ISC2-PX, ISC2-XP, ISC2-682PX and ISC2-682XP

The ISC2-PX single cartridge pusher seal brings superior reliability to ASME, ISO and JIS pumps used in chemical, power, water, pulp and paper, and general industries. ISC2-682 versions provide full API 682 compliance.

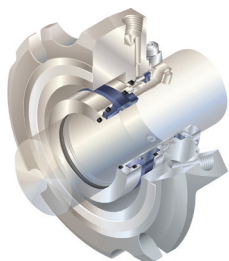

- Increased reliability with thermal management technology that runs cooler in suboptimal conditions such as short-term dry running events
- Longer service life enabled by corrosion-resistant design and drive mechanisms that reduce wear in high-vibration applications
- Comprehensive range of pre-engineered configurations with standard flush (PX), Plan 23 cooling (XP); custom solutions available
- Increased safety delivered by throttle bushing with standard quench and drain for safe containment in the unlikely event of seal failure

SPECIFICATIONS

Press. to: 20.6 bar (300 psi)
 Temp: -40°C to 204°C (-40°F to 400°F)
 Speeds to: 23 m/s (75 fps)
 Sizes: 25 to 200 mm (1.000 to 8.000 in)
 Refer to literature FSD243
 at flowserve.com/library.

INDUSTRIAL PROCESS

ISC2-PP and ISC2-682PP

These dual cartridge pusher seals from the versatile ISC2 Series bring superior reliability to ASME, ISO, JIS and API pumps used in chemical, power, water, oil and gas, and other industries.

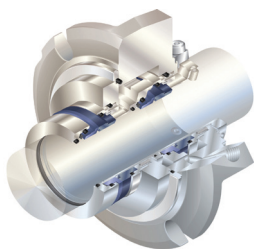

- Reliable operation resulting from advanced volute groove design and internal circulating devices that promote cool running
- Longer service life via a stationary face support drive mechanism that reduces wear in applications with high vibration levels, and springs and pins outside the process for reduced corrosion and clogging
- Application flexibility with double-balanced seal face geometry, allowing both pressurized and unpressurized operation; ISC2-682PP provides full API 682 compliance

SPECIFICATIONS

Press. to: 20.6 bar (300 psi)
 Temp: -40°C to 204°C (-40°F to 400°F)
 Speeds to: 23 m/s (75 fps)
 Sizes: 25 to 200 mm (1.000 to 8.000 in)
 Refer to literature FSD243
 at flowserve.com/library.

INDUSTRIAL PROCESS

QB, QBS and QBU

QB Series balanced pusher seals are ideal for medium-duty applications in power and industrial applications.

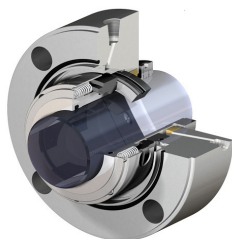

- Greater reliability and installation ease assured by rugged components, heavy-duty seal faces and cartridge seal configuration
- Combat dirty services with the clog-resistant large cross-section, single coil spring in the QBS seal
- Handle low lubricity hot water without the need for auxiliary cooling systems with the QBU seal
- Choice of throttle bushing design: fixed, floating or segmented for safe equipment operation

SPECIFICATIONS

Press. to: 51.7 bar (750 psi)
 Temp: -40°C to 204°C (-40°F to 400°F)
 Speeds to: 23 m/s (75 fps)
 Sizes: 12.7 to 139.7 mm (0.500 to 5.500 in)
 Refer to literature FSD152
 at flowserve.com/library.

PUSHER

INDUSTRIAL PROCESS

UC and UCQ

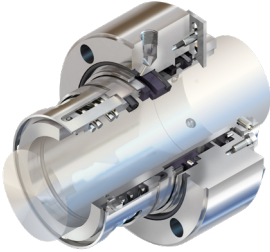

The UC Series is a balanced pusher seal with a substantial single coil spring that provides exceptional performance in refinery, pipeline and petrochemical services.

- Extended service life in heavy-duty applications assured by rugged single pusher seal with thick cross-section components
- Increased reliability via large, low spring rate single coil spring that tolerates axial setting dimensions while reducing opportunity for clogging and hang-up from solids
- Consistent seal face contact provided by robust U-cup seal and spring holder
- Low-emissions performance enabled by silicon carbide rotating face mounted on graphite ring, preventing shrink fit distortions and sustaining a flat seal face

SPECIFICATIONS

Press. to: 27.6 bar (400 psi)
Temp: -40°C to 204°C (-40°F to 400°F)
Speeds to: 23 m/s (75 fps)
Sizes: 14.1 to 148 mm
(0.566 to 5.838 in)

Refer to literature FSD110
at flowserve.com/library.

INDUSTRIAL PROCESS

RO

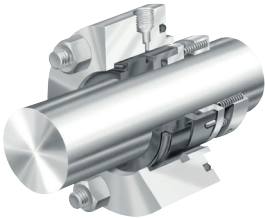

This single, unbalanced, multi-spring component seal is usable as an inside or outside mounted seal. Suitable for abrasive, corrosive and viscous fluids in chemical services.

- Increased durability from robust rotating spring compression unit that helps to keep solids away from the seal faces and removes seal-generated heat
- Improved reliability with rotating seal ring that is independently centered on the shaft and has multiple springs and drive pins that evenly distribute the load
- Broad application flexibility enabled by completely interchangeable shaft packing materials, dimensionally interchangeable insert mounting, and compression unit availability in any machinable metallurgy

SPECIFICATIONS

Press. to: 20.7 bar (300 psi)
Temp: -40°C to 260°C (-40°F to 500°F)
Speeds to: 23 m/s (75 fps)
Sizes: 9.5 to 115 mm
(0.375 to 4.500 in)

Refer to literature FSD155
at flowserve.com/library.

INDUSTRIAL PROCESS

CRO

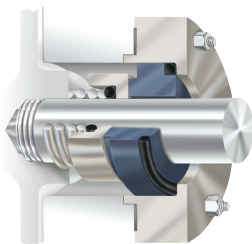

The CRO is an economical, single-coil spring, friction drive component seal for use in pumps with packing box seal chambers. Available in single or dual arrangements.

- Longer service life derived from rotating seal ring that self-centers around the shaft and withstands the harsh demands of cyclic operation or continuous duty
- Increased durability from robust single-coil spring that resists clogging and chemical attack
- Simplified installation and improved corrosion resistance due to a design with a minimum number of seal components with heavy cross-sections

SPECIFICATIONS

Press. to: 20.7 bar (300 psi)
Temp: -40°C to 260°C (-40°F to 500°F)
Speeds to: 23 m/s (75 fps)
Sizes: 9.5 to 115 mm
(0.375 to 4.500 in)

Refer to literature FSD169
at flowserve.com/library.

INDUSTRIAL PROCESS

Europac Series

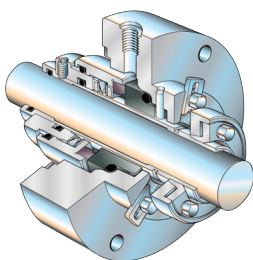

Europac single, wavy spring seals are designed for ISO pumps in a wide range of duties in chemical and general industries. Designed according to metric DIN EN 12 756 standard to L1k.

- Longer service life assured by rigid, corrosion-resistant retainer with or without integrated pumping thread
- Increased reliability delivered by X-spring with anti-axial displacement and rigid PTFE or elastomers for secondary sealing
- Broad application versatility provided by multiple arrangements, including standard design (600), balanced stepped shaft (610) and hot water services without cooling (615)

SPECIFICATIONS

Press. to: 25 bar (360 psi)
 Temp: -40°C to 220°C (-40°F to 430°F)
 Speeds to: 23 m/s (75 fps)
 Sizes: 10 to 100 mm
 (0.394 to 3.940 in)

Refer to literature FSD128
 at flowserve.com/library.

INDUSTRIAL PROCESS

RA and RA-C

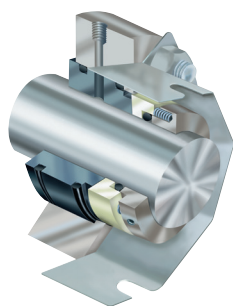

With its composite rotor, the RA single outside-mounted component seal is a cost-effective solution for highly corrosive chemical services. Suitable for metallic and nonmetallic equipment, such as plastic, glass and lined designs.

- Installation ease with design that attaches to the outside of the seal chamber
- Corrosive application performance and flexibility provided by seal faces and elastomers in diverse materials, plus non-wetted drive collar, springs and drive pins on the RA-C configuration to avoid the need for expensive alloys
- Greater reliability assured by flexible rotor design, hydraulically balanced to provide proper face loading
- Better process control via double O-ring mounted stator that prevents distortion

SPECIFICATIONS

Press. to: 27.6 bar (400 psi)
 Temp: -40°C to 177°C (-40°F to 350°F)
 Speeds to: 23 m/s (75 fps)
 Sizes: 13 to 127 mm
 (0.500 to 5.000 in)

Refer to literature FSD170
 at flowserve.com/library.

Learn to Visually Identify Seal Failures

Troubleshoot seal failures with the Flowserve Seal Failure Analysis app. This tool is an invaluable resource for maintenance personnel and reliability engineers tasked with maximizing equipment uptime. You'll learn the tell-tale signs for visually identifying more than 60 seal failure modes plus typical causes and options for prevention. You can also get a second opinion from a Flowserve seal expert, locate nearby Quick Response Centers, access handy reference materials and watch seal-related videos.

Find it at www.sealfailureapp.com.



PUSHER

API PROCESS

QBQ and QBQ LZ

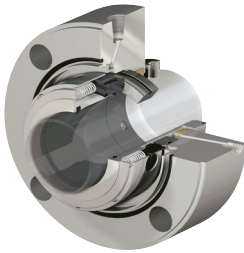

This medium- to high-pressure seal features a high balance face that meets the lowest light hydrocarbon emissions level: less than 500 ppm. Designed to suppress flashing and minimize heat generation.

- Satisfies all API 682 design and qualification test requirements for single and dual Arrangement 1 and 2 seals
- Extended equipment reliability with optimal face cooling and reduced distortion from available multiport injection
- Safety and environmental compliance assured by dual seal arrangement, which provides safety backup and emissions control in hazardous services
- Handle low vapor pressure margin with the QBQ LZ seal, featuring wave pattern precision face topography to minimize heat generation and seal face wear

SPECIFICATIONS

Press. to: 51.7 bar (750 psi)
Temp: -40°C to 204°C (-40°F to 400°F)
Speeds to: 23 m/s (75 fps)
Sizes: 12.7 to 139.7 mm (0.500 to 5.500 in)

Refer to literature FSD152 and FSD216 at flowserve.com/library.

API PROCESS

QBB and QB2B

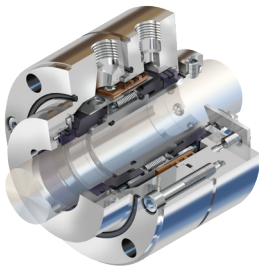

Engineered to handle reverse pressurization, the QBB and QB2B dual pressurized pusher seals are capable of zero emissions. Provides full range pressure capability for API 682 Arrangement 3 requirements.

- Increased durability from ability to handle reverse pressurization upsets with capabilities that far exceed conventional balanced seals
- All parts are mechanically or hydraulically retained in place, regardless of the direction of pressurization
- Environmental compliance with design optimized for pressurized barrier fluid
- Low to moderate pressures are handled by the QBB face-to-back configuration
- Moderate and high pressures, including Piping Plan 53B, are handled by the QB2B back-to-back configuration

SPECIFICATIONS

Press. to: 51.7 bar (750 psi)
Temp: -40°C to 204°C (-40°F to 400°F)
Speeds to: 23 m/s (75 fps)
Sizes: 20 to 121 mm (0.787 to 4.750 in)

Refer to literature FSD152 at flowserve.com/library.

API PROCESS

HSH

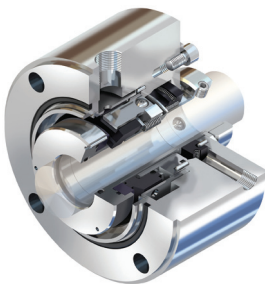

HSH balanced, flexible stator cartridge seals are built for extended reliability in high-pressure, high-speed and highly viscous services such as crude oil pipeline pumps. Fully compliant with API 682 Type A, Arrangements 1, 2 and 3.

- Extended service life via high torque-capable, anti-rotation lugs that minimize distortion and wear
- Greater efficiency from standard distribution ring connected to the seal's flush port, which improves cooling efficiency by injecting flush flow 360° around seal faces
- Reliable high-speed operation and improved tolerance of misalignment enabled by flexible stator design with Alloy C-276 springs
- Decreased inventory costs and increased design flexibility owing to parts interchangeability between single and dual seal arrangements

SPECIFICATIONS

Press. to: 103 bar (1500 psi)
Temp: -40°C to 260°C (-40°F to 500°F)
Speeds to: 46 m/s (150 fps)
Sizes: 25.4 to 156 mm (1.000 to 6.125 in)

Refer to literature FSD156 at flowserve.com/library.

PUSHER

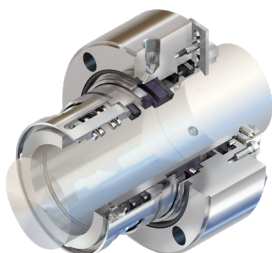
UO and UOP

The UO Series is a balanced pusher seal based on the UC Series with high-pressure features. UO Series seals are well-suited for demanding refinery, pipeline and petrochemical services.

- Extended service life in high-pressure, heavy-duty applications assured by rugged single pusher seal with thick cross-section components
- Increased reliability via large, low spring rate single coil spring that tolerates axial setting dimensions while reducing clogging and hang-up from solids
- Consistent seal face contact provided by robust U-cup seal and spring holder
- High-pressure performance enabled by engineering the seal face mounting to prevent distortions under all load conditions

SPECIFICATIONS

Press. to: 103.4 bar (1500 psi)
Temp: -40°C to 204°C (-40°F to 400°F)
Speeds to: 23 m/s (75 fps)
Sizes: 14.1 to 148 mm
(0.566 to 5.838 in)

Refer to literature FSD255
at flowserve.com/library.

HIGH-ENERGY PROCESS

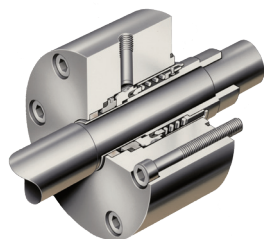
D and DP

D Series single spring, balanced pusher seals have a high-circulation integral pumping ring to ensure proper cooling. Ideal for high-temperature boiler feed water and hot hydrocarbon services.

- Cost-effective operation ensured by integrated pumping ring that eliminates the expense of cool injection systems
- Greater reliability due to the rotating face that remains flat under all conditions for very low leakage
- Consistent seal face contact provided by robust U-cup seal and spring holder
- Superior high-temperature performance enabled by large, low spring rate single coil spring that tolerates axial setting variations

SPECIFICATIONS

Press. to: 103.4 bar (1500 psi)
Temp: -73°C to 343°C (-100°F to 650°F)
Speeds to: 23 m/s (75 fps)
Sizes: 13.4 to 137 mm
(0.525 to 5.400 in)

Refer to literature FSD153
at flowserve.com/library.

HIGH-ENERGY PROCESS

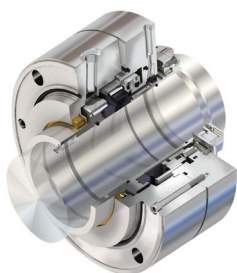
UHTW and DHTW

These high-speed, high-pressure balanced pusher seals are custom-engineered for high-energy applications such as boiler-feed process barrel pumps.

- Unmatched performance and extended seal life derived from FEA-designed seal faces that boast zero net deflection from thermal, hydraulic, and dynamic forces
- Superior high temperature, slow roll, and hot standby operation enabled by high performance circulating features that deliver optimum cooling at all operating speeds
- Reliable operation in high speed services achieved via precisely controlled seal face balance ratio and robust drive engagement
- Extended equipment uptime with available secondary containment options

SPECIFICATIONS

Press. to: 207 bar (3000 psi)
Temp: -40°C to 371°C (-40°F to 700°F)
Speeds to: 76 m/s (250 fps)
Sizes: 25.4 to 228.6 mm
(1.000 to 9.000 in)

Refer to literature FSD140
at flowserve.com/library.

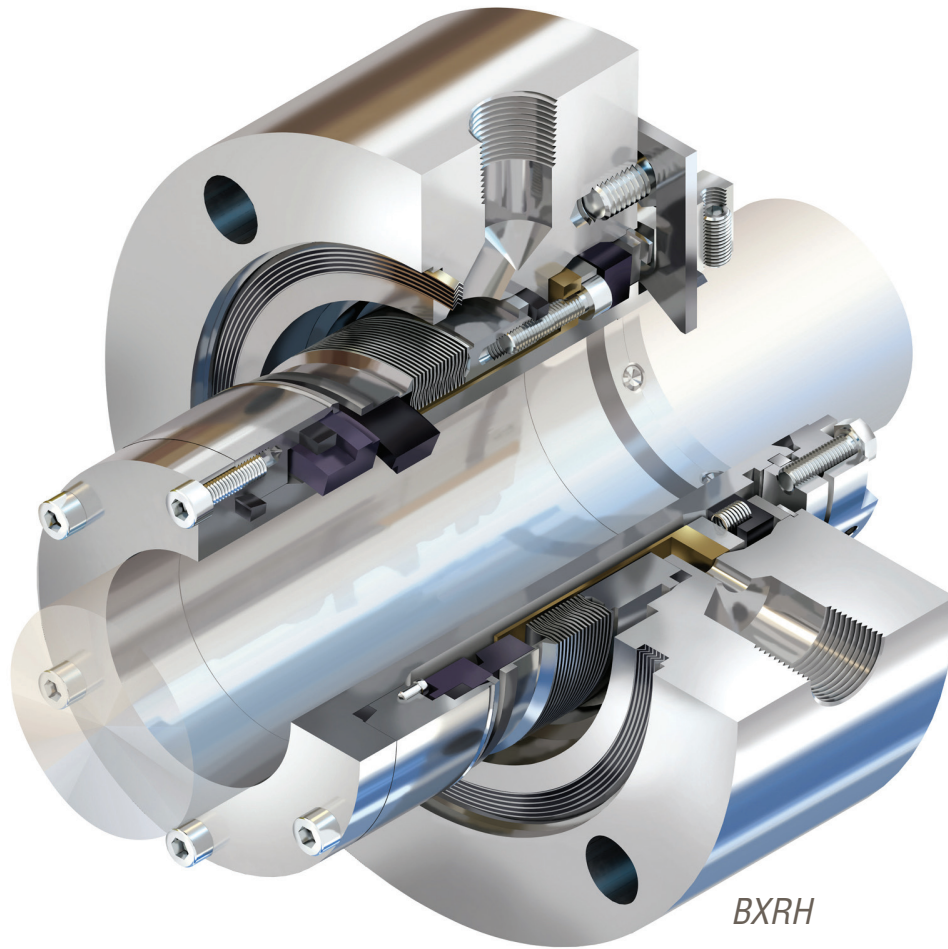

BXRH

METAL BELLOWS

Flowserve metal bellows seals provide proven reliability and long-term performance in general and critical services, whether you're dealing with hazardous chemicals or refinery processing. Edge-welded, high-alloy bellows get the job done where corrosive chemicals degrade elastomers and other dynamic gaskets. Available with rotating or stationary bellows and in single, dual unpressurized or dual pressurized configurations, our global customers will find a variety of arrangements to meet their toughest sealing requirements, including full API 682 compliance.

Metal Bellows – Quick Reference

Product	Sub-Type	Pressures to	Temperatures	Speeds to	Sizes
ISC2-BX, ISC2-XB, ISC2-682BX and ISC2-682XB	Industrial Process	13.8 bar (200 psi)	-40°C to 204°C (-40°F to 400°F)	23 m/s (75 fps)	25 to 95 mm (1.000 to 3.750 in)
ISC2-BB	Industrial Process	13.8 bar (200 psi)	-40°C to 204°C (-40°F to 400°F)	23 m/s (75 fps)	25 to 95 mm (1.000 to 3.750 in)
BXLS	Industrial Process	27.6 bar (400 psi)	-40°C to 204°C (-40°F to 400°F)	23 m/s (75 fps)	16 to 100 mm (0.623 to 3.937 in)
BX, BXQ and BXB	API Process	27.6 bar (400 psi)	40°C to 204°C (-40°F to 400°F)	23 m/s (75 fps)	12.3 to 127 mm (0.483 to 5.000 in)
BXRH	API Process	20.7 bar (300 psi)	-73°C to 427°C (-100°F to 800°F)	46 m/s (150 fps)	21.8 to 127 mm (0.857 in to 5.000 in)
BXHHS and BXHHSB	API Process	20.7 bar (300 psi)	-73°C to 427°C (-100°F to 800°F)	23 m/s (75 fps)	28.2 to 128.9 mm (1.110 in to 5.073 in)
BRC and BRCSH	API Process	20.7 bar (300 psi)	-73°C to 427°C (-100°F to 800°F)	23 m/s (75 fps)	28.2 to 150 mm (1.110 to 5.906 in)

METAL BELLOWS

INDUSTRIAL PROCESS

ISC2-BX, ISC2-XB, ISC2-682BX and ISC2-682XB

Single cartridge metal bellows seals from the versatile ISC2 Series, the ISC2-BX and ISC2-XB are ideal for a wide range of chemical and industrial applications. ISC2-682 versions provide full API 682 compliance.

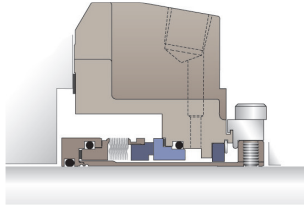

- Outstanding corrosion resistance with edge-welded Alloy C-276 bellows
- Reduced hang-up due to self-cleaning rotating bellows design that maintains excellent seal face loading
- Improved tolerance to dry running events with exclusive thermal management technology
- Broad application flexibility assured by comprehensive range of pre-engineered configurations with standard flush (BX), Plan 23 cooling (XB) and API 682 compliance
- Increased safety via throttle bushing with standard quench and drain

SPECIFICATIONS

Press. to: 13.8 bar (200 psi)
Temp: -40°C to 204°C (-40°F to 400°F)
Speeds to: 23 m/s (75 fps)
Sizes: 25 to 95 mm (1.000 to 3.750 in)
Refer to literature FSD243
at flowserve.com/library.

INDUSTRIAL PROCESS

ISC2-BB and ISC2-682BB

This dual cartridge metal bellows seal from the versatile ISC2 Series provides a reliable barrier against process leakage in chemical and industrial applications. The ISC2-682 BB provides full API 682 compliance.

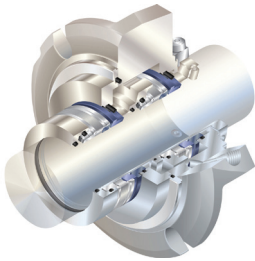

- Reliable operation resulting from advanced volute groove design and internal circulating devices that promote cool running
- High uptime with corrosion-resistant, edge-welded Alloy C-276 bellows
- Reduced hang-up due to self-cleaning rotating bellows design
- Application flexibility with tandem and double-balanced arrangements to allow both pressurized and unpressurized operation
- Meets all major international standards and fits hundreds of pump models from global manufacturers

SPECIFICATIONS

Press. to: 13.8 bar (200 psi)
Temp: -40°C to 204°C (-40°F to 400°F)
Speeds to: 23 m/s (75 fps)
Sizes: 25 to 95 mm (1.000 to 3.750 in)
Refer to literature FSD243
at flowserve.com/library.

INDUSTRIAL PROCESS

BXLS

The BXLS is a metric-sized rotating metal bellows seal for corrosive and non-corrosive services, especially those that crystallize. Meets the seal chamber dimensions specified by DIN EN 12 756 L1k.

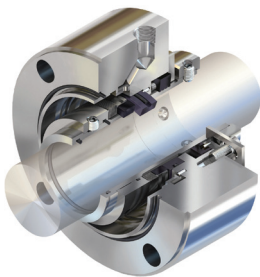

- Metric seal interface dimensions ideal for pumps conforming to various DIN and ISO standards, including DIN 24960 and ISO 3069
- Installation flexibility afforded by cartridge or non-cartridge seal configurations to fit the seal chamber dimensional requirements
- Reduced maintenance costs due to the absence of springs and dynamic elastomers to lessen clogging vulnerabilities
- Longer service life with 0.20 mm (0.008 in) thick standard welded metal bellows for extended resistance to corrosion, vibration and centrifugal forces

SPECIFICATIONS

Press. to: 27.6 bar (400 psi)
Temp: -40°C to 204°C (-40°F to 400°F)
Speeds to: 23 m/s (75 fps)
Sizes: 16 to 100 mm (0.623 to 3.937 in)
Refer to literature FSD109
at flowserve.com/library.

API PROCESS

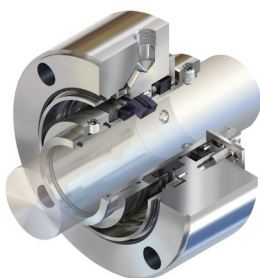
BX, BXQ and BXB

BX Series balanced rotating metal bellows seals provide exceptional reliability in corrosive and non-corrosive fluids, especially those that crystallize. Fully compliant with API 682 Type B, Arrangements 1, 2 and 3.

- Longer service life with 0.20 mm (0.008 in) thick standard welded metal bellows for resistance to corrosion, shaft vibration and centrifugal forces
- Optimal performance ensured by three standard seal face balances; the BXQ seal is high balanced for flashing hydrocarbon applications
- Increased maintenance intervals due to self-cleaning rotating bellows that replace springs and dynamic elastomers
- Performance benefits of metal bellows in dual pressurized Arrangement 3 seals with the BXB seal's unique ID pressurized seal face balance

SPECIFICATIONS

Press. to: 27.6 bar (400 psi)
 Temp: -40°C to 204°C (-40°F to 400°F)
 Speeds to: 23 m/s (75 fps)
 Sizes: 12.3 to 127 mm (0.483 to 5.000 in)

Refer to literature FSD109 at flowserve.com/library.

API PROCESS

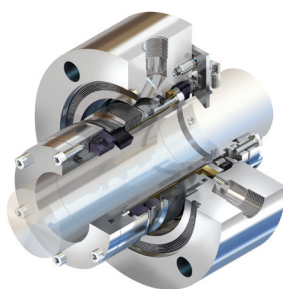
BXRH

Built for temperatures beyond the limits of elastomers, the BXRH balanced stationary metal bellows seal offers reliable sealing at high speeds. Meets all API 682 Type C requirements in Arrangements 1, 2 and 3.

- Optimal performance resulting from flexible graphite gasketing in lieu of elastomers to improve temperature and chemical compatibility
- Reliability due to extra-long Alloy 718 bellows that offer superior corrosion resistance, allow more axial travel, and provide consistent spring loading
- Application flexibility arising from single and dual seal configurations as well as pressurized and unpressurized arrangements
- Reduced clogging due to absence of springs and dynamic elastomers, plus standard anti-coke device

SPECIFICATIONS

Press. to: 20.7 bar (300 psi)
 Temp: -73°C to 427°C (-100°F to 800°F)
 Speeds to: 46 m/s (150 fps)
 Sizes: 21.8 to 127 mm (0.857 in to 5.000 in)

Refer to literature FSD111 at flowserve.com/library.

API PROCESS

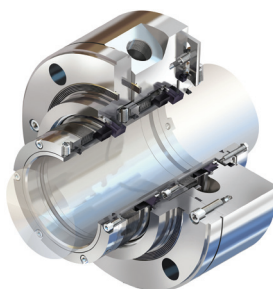
BXHHS and BXHHSB

BXHHS and BXHHSB balanced rotating metal bellows seals are designed for refinery and petrochemical services at high- and low-temperature extremes. Meets API 682 Type C requirements in Arrangements 1, 2 and 3.

- Optimal performance resulting from flexible graphite gasketing in lieu of elastomers to improve temperature and chemical compatibility
- High uptime due to corrosion-resistant Alloy 718 bellows construction and a low-stress design
- Compact overall length designed to fit in API 610 pumps without modification
- Reliable operation ensured by extended travel bellows core that allows for extreme linear shaft growth, typical in high-temperature pumping
- Distortion-free face design maintains flatness throughout operating range

SPECIFICATIONS

Press. to: 20.7 bar (300 psi)
 Temp: -73°C to 427°C (-100°F to 800°F)
 Speeds to: 23 m/s (75 fps)
 Sizes: 28.2 to 128.9 mm (1.110 in to 5.073 in)

Refer to literature FSD111 at flowserve.com/library.

METAL BELLOWS

API PROCESS

BRC and BRCSH

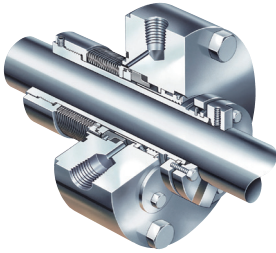

These robust balanced metal bellows seals are designed for high-temperature hydrocarbons, heat transfer fluids and other severe services. Meet all API 682 Type C requirements in Arrangements 1, 2 and 3.

- Longer service life ensured by edge-welded, thick-plate Alloy 718 bellows that comply with NACE MR0103 criteria and withstand long-term chemical exposure
- Reliability resulting from the canned face design that eliminates shrink-fit distortions and allows low-leakage performance
- Prolonged clean operation due to steam purge baffle on stationary configurations that eliminates coking
- Application flexibility accommodates extreme shaft movement in single or dual seal arrangements

SPECIFICATIONS

Press. to: 20.7 bar (300 psi)
Temp: -73°C to 427°C (-100°F to 800°F)
Speeds to: 23 m/s (75 fps)
Sizes: 28.2 to 150 mm (1.110 to 5.906 in)

Refer to literature FSD142 at flowserve.com/library.

The Highest Standards of Safety

Our customers find in Flowserve a partner that is closely aligned with their standards of a safe operating environment. Our overall, industry-recognized performance far exceeds our peers, rivaling that of industry award winners. It's a continuously improving part of our business, where we've established a safety-first culture with processes that demonstrate reductions in lost time accidents, lower total recordable rates and improvements in near-miss reporting.



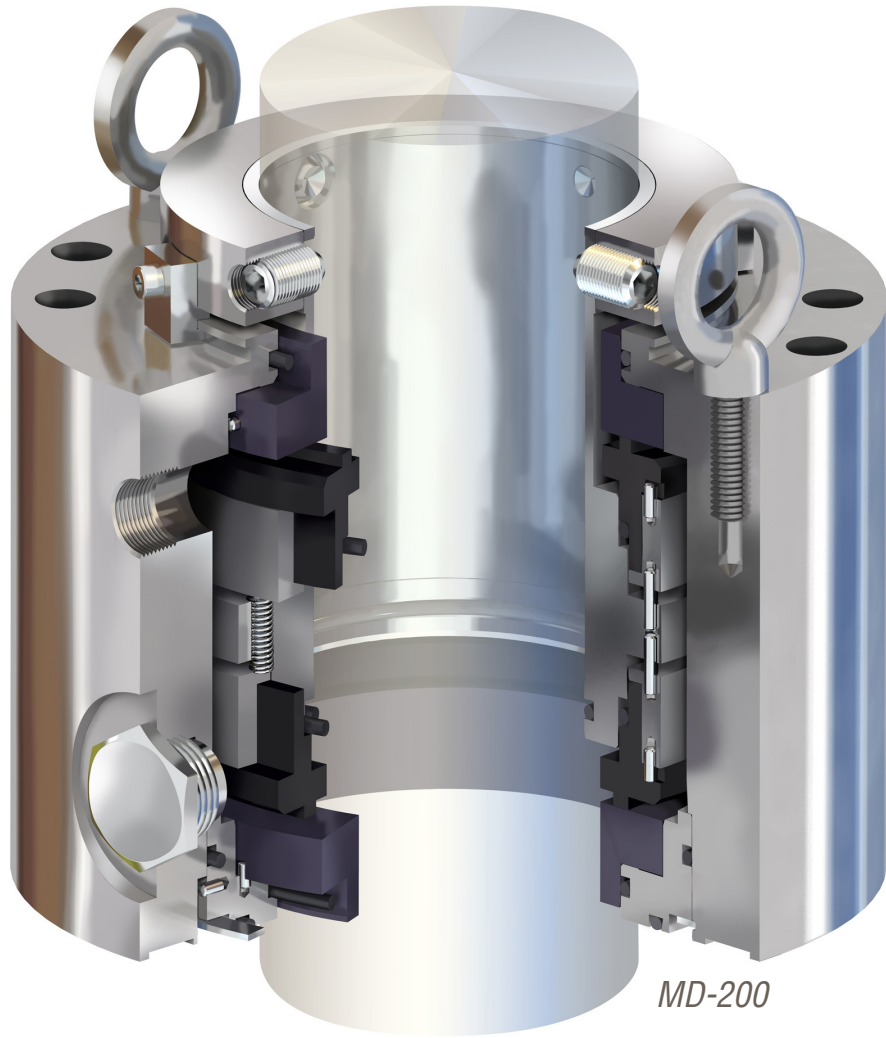

MD-200

MIXER

Flowserve mixer seals are designed to handle significant radial and axial shaft run-out while keeping workers safe and protecting the environment. Cost-effective performance, safety and reliability are engineered into every seal so total costs stay low. Choose from a variety of cartridge or split designs for top-, side- or bottom-entry installations or have seals custom-tailored to your specifications. Plus, every design is backed by our savvy rotating equipment specialists. They have the industry knowledge and skills to help extend the reliability of all kinds of agitating, blending, drying, filtering, separating and processing equipment.

Mixer – Quick Reference

Product	Valve Type	Pressures	Temperatures	Speeds	Sizes
M Series	Mixer & Specialty Equipment	vacuum to 35 bar (500 psi)	to 200°C (390°F)	to 10 m/s (33 fps)	40 to 220 mm (1.575 to 9.000 in)
Mixerpac	Mixer & Specialty Equipment	vacuum to 250 bar (3600 psi)	to 200°C (390°F)	to 10 m/s (33 fps)	25 to 365 mm (1.000 to 14.400 in)
VRA	Mixer & Specialty Equipment	vacuum to 13.8 bar (200 psi)	to 121°C (250°F)	to 350 rpm	25 to 178 mm (1.000 to 7.000 in)
MSS	Mixer & Specialty Equipment	vacuum to 7 bar (100 psi)	to 150°C (300°F)	to 1740 rpm	25 to 305 mm (1.000 to 12.000 in)
ST	Mixer & Specialty Equipment	vacuum to 3.4 bar (50 psi)	-40°C to 135°C (-40°F to 275°F)	to 4 m/s (13 fps)	25.4 to 108 mm (1.000 to 4.250 in)
ISC2-MW	Mixer Equipment	to 6.9 bar (100 psi)	-40°C to 204°C (-40°F to 400°F)	to 1.1 m/s (3.5 fps)	25 to 200 mm (1.000 to 8.000 in)

MIXER

MIXER & SPECIALTY EQUIPMENT

M Series

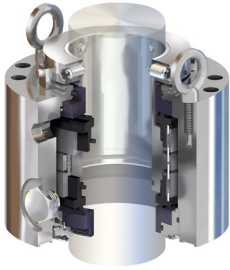

M Series vertical shaft mixer seals easily adapt to changing production requirements. They are designed for use with mixers, agitators, filters and dryers as well as steel- or glass-lined vessels.

- Unprecedented application flexibility provided by cartridge canister design that enables the seal faces to be changed out to run wet (MW), dry contacting (MD) or dry non-contacting gas barrier technology (ML)
- True component standardization with reduced inventory carrying costs owing to a high degree of parts interchangeability across the product line
- Optional materials compliant with FDA CFR 21, USP Class VI, ADI Free Components and similar specifications
- Specialized solutions customized up to 480 mm (18.900 in) shaft size (MWC-200)

SPECIFICATIONS

Press: vacuum to 35 bar (500 psi)
Temp: to 200°C (390°F)
Speed: to 10 m/s (33 fps)
Sizes: 40 to 220 mm
(1.575 to 9.000 in)

Refer to literature FSD104
at flowserve.com/library.

MIXER & SPECIALTY EQUIPMENT

Mixerpac

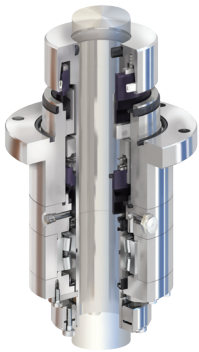

The Mixerpac family of mixer seals is designed for top-, side- and bottom-entry installations. Configurations available for slurry, sterile, high-pressure or large shaft movement applications.

- Broad application flexibility owing to modular cartridge construction with and without bearing as well as liquid-lubricated and gas lift-off designs
- Extended seal life due to reduced friction and wear from balanced dual-pressurized design and seal faces optimized through FEA
- Reliable operation and improved safety with available reverse-pressure capability and emergency sealing solutions
- Numerous options, including cooling flange and sanitary gland/debris catcher, for applications requiring steam cleaning

SPECIFICATIONS

Press: vacuum to 250 bar (3600 psi)
Temp: to 200°C (390°F)
Speed: to 10 m/s (33 fps)
Sizes: 25 to 365 mm
(1.000 to 14.400 in)

Refer to literature FSD104
at flowserve.com/library.

MIXER & SPECIALTY EQUIPMENT

VRA

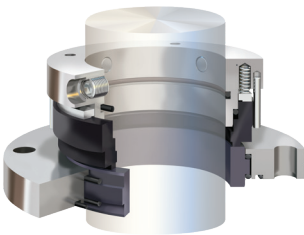

The VRA is an outside-mounted, dry-running single pusher seal designed to operate on top-entry agitators and mixers. Self-lubricating carbon or filled PTFE seal faces run completely dry without cooling.

- Cost savings provided by contacting dry-running design and two-piece collar, which respectively eliminate the need for a buffer fluid system and expensive alloys in non-wetted areas
- Optimized for high run-out requirements — up to 3.81 mm (0.150 in) FIM
- High reliability provided by flexible rotor design that compensates for misalignment and double O-ring mounted stator that prevents distortion
- Reduced downtime facilitated by optional sanitary gland that allows steam cleaning and sterilizing of the seal's interior while mounted on the equipment

SPECIFICATIONS

Press: vacuum to 13.8 bar (200 psi)
Temp: to 121°C (250°F)
Speed: to 350 rpm
Sizes: 25 to 178 mm (1.000 to 7.000 in)

Refer to literature FSD167
at flowserve.com/library.

MIXER & SPECIALTY EQUIPMENT

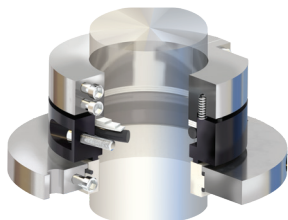
MSS

The MSS is for tough mixer and vessel applications where stuffing box face, bore and OD run-out are extreme. Typically used on older equipment or where compression packing had been used.

- Easy installation, inspection and maintenance facilitated by outside seal arrangement and split design
- Fits in tight spaces with no equipment tear down; can be installed in cramped stuffing box areas where the bearing housing, gear box or coupling create obstructions
- Reliable operation owing to self-lubricating faces and design that dissipates heat from seal faces, which allows it to run dry or wet
- Product purity ensured by design that compensates for pressure reversals

SPECIFICATIONS

Press: vacuum to 7 bar (100 psi)
 Temp: to 150°C (300°F)
 Speed: to 1740 rpm
 Sizes: 25 to 305 mm
 (1.000 to 12.000 in)

For more information, refer to FSD162.

MIXER & SPECIALTY EQUIPMENT

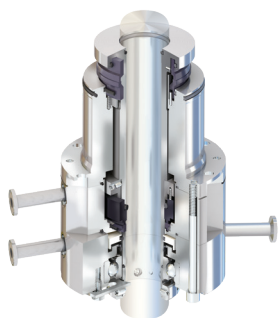
ST

The ST is a bottom-entry mixer seal designed for the ruggedness and reliability necessary in sterile environments, such as bioreactors. Suitable for CIP and SIP use.

- Sterile operation ensured by sloped non-pooling, product-side design that minimizes crevices and is drainable
- Cartridge seal ensures installation ease and can be fitted with a bearing to help steady the shaft
- Highly reliable liquid-lubricated, dual-pressurized design eliminates leakage and protects process integrity
- Materials compliant with FDA CFR 21 and USP Class VI; all components are ADI free

SPECIFICATIONS

Press: vacuum to 3.4 bar (50 psi)
 Temp: -40°C to 135°C (-40°F to 275°F)
 Speed: to 4 m/s (13 fps)
 Sizes: 25.4 to 108 mm
 (1.000 to 4.250 in)

For more information, refer to FSD104 and FSD147.

MIXER EQUIPMENT

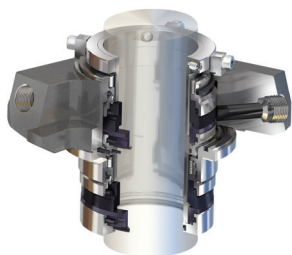
ISC2-MW

The ISC2-MW is a dual-arrangement standard cartridge pusher seal engineered for reliable, cost-effective operation in mixer service.

- Reduced installation and maintenance costs assured by economical cartridge seal design for top-entry installation
- Increased uptime resulting from volute groove, which significantly increases barrier fluid flow to promote cool running, even at mixer speeds
- Reliable operation ensured by ISC2 thermal management technology that allows the seal to run cooler and tolerate dry-running events

SPECIFICATIONS

Press: to 6.9 bar (100 psi)
 Temp: -40°C to 204°C (-40°F to 400°F)
 Speed: to 1.1 m/s (3.5 fps)
 Sizes: 25 to 200 mm (1.000 to 8.000 in)

For more information, refer to FSD104.

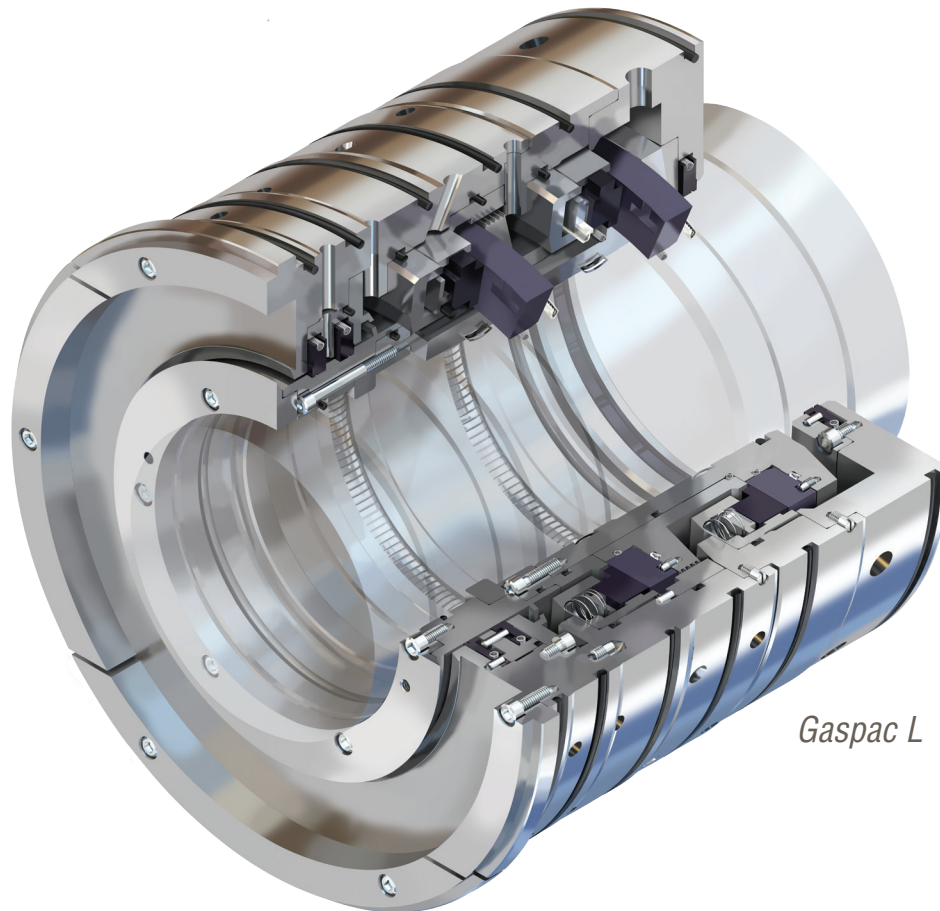

Gaspac L

COMPRESSOR SEALS AND SYSTEMS

Our Gaspac, Circpac, and Turbopac seals have earned their reputation as the most advanced compressor sealing solutions available. Even more, they're backed by a global team that leads the industry in dry gas seal retrofits, high-end compressor seal troubleshooting, seal support engineering, and world-class gas conditioning systems. By combining leading-edge technologies and service, Flowserve allows compressor customers to reach higher pressure, efficiency and profitability.

Compressor Seals and Systems – Quick Reference

Product	Sub-Type	Pressures	Temperatures	Speeds to	Sizes
Gaspac® T, L, D and S	Gas Compressor Process	650 bar (9427 psi)	to 230°C (450°F)	250 m/s (820 fps)	to 360 mm (14.125 in)
Circpac™ CB, LO and HP	Gas Compressor Process	10 bar (150 psi)	-40°C to 180°C (-40°F to 350°F)	140 m/s (460 fps)	to 280 mm (11.000 in)
Turbopac™ 378 and 2100	Gas Compressor Process	300 bar (4300 psi)	to 180°C (550°F)	100 m/s (330 fps)	40 to 260 mm (1.500 to 10.250 in)
Supplypac™	Gas Support System	414 bar (6000 psi)	to 240°C (400°F)	—	—
Cleanpac™ D, F and DL	Gas Support System	550 bar (8000 psi)	to 204°C (400°F)	—	—
Ampliflow™	Gas Support System	550 bar (8000 psi)	to 204°C (400°F)	—	—
Drypac™	Gas Support System	550 bar (8000 psi)	to 204°C (400°F)	—	—
N2 Genpac™	Gas Support System	13 bar (190 psi)	to 50°C (122°F)	—	—

COMPRESSOR SEALS AND SYSTEMS

GAS COMPRESSOR PROCESS

Gaspac T, L, D and S

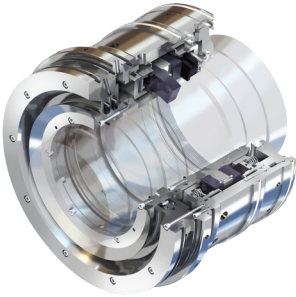

The Gaspac is a proven platform of dry gas seals for turbomachinery equipment and features either bi-directional T-Groove or Advanced Pattern Groove (APG) non-contacting seal face technologies.

- Environmental regulatory compliance and energy savings assured by controlled gas flow rates over the widest operating conditions
- Increased reliability with precision face topography that offers high film stiffness and damping, and maintains a stable gas film under slow roll and high speeds
- Application versatility from a wide range of single and dual configurations with process barrier and oil exclusion features
- Increased uptime via innovative solutions for secondary sealing, reverse rotation, reverse pressurization and component centering

SPECIFICATIONS

Press. to: 650 bar (9427 psi)
Temp: to 230°C (450°F)
Speeds to: 250 m/s (820 fps)
Sizes: to 360 mm (14.125 in)

Refer to literature FSD113
at flowserve.com/library.

GAS COMPRESSOR PROCESS

Circpac CB, LO and HP

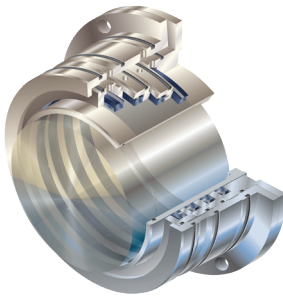

This high-performance segmented circumferential gas seal series is engineered for gas compressors as part of a Gaspac assembly (Circpac CB and LO) or as a stand-alone cartridge (Circpac HP).

- Consistent performance from carbon ring construction designed for non-contacting operation that exceeds the pressure capability of typical circumferential seals
- Increased reliability via pressure-balanced ring design and hydrodynamic surface features, resulting in low gas consumption and long life
- Enhanced application versatility enabled by multiple ring combinations with optimized purge and vent options
- Lower cost of ownership with fewer spare parts provided by bi-directional capability for reverse rotation

SPECIFICATIONS

Press. to: 10 bar (150 psi)
Temp: -40°C to 180°C (-40°F to 350°F)
Speeds to: 140 m/s (460 fps)
Sizes: to 280 mm (11.000 in)

Refer to literature FSD113
at flowserve.com/library.

GAS COMPRESSOR PROCESS

Turbopac 378 and 2100

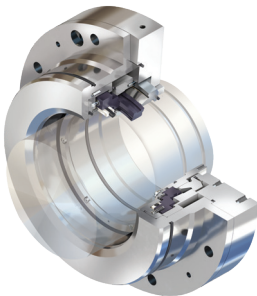

The Turbopac is a highly dependable oil-lubricated, bi-directional mechanical seal designed for screw, turbo and high-pressure, high-speed applications.

- Increased performance and rotational speeds from stationary spring assembly
- Enhanced safety of operations during emergency shutdowns enabled by dual-acting static seal that allows for product containment under reverse pressure conditions
- Improved ease of installation via cartridge design
- Reduced leakage and added efficiency from design that minimizes oil loss
- Application flexibility owing to availability of single and double arrangements

SPECIFICATIONS

Press. to: 300 bar (4300 psi)
Temp: to 180°C (550°F)
Speeds to: 100 m/s (330 fps)
Sizes: 40 to 260 mm (1.500 to 10.250 in)

Refer to literature FSD113
at flowserve.com/library.

An Ultra-High Bar

In compressor services — where higher pressure often means higher efficiency and greater profitability — Gaspac seals set the performance benchmark. Able to handle high speeds and ultra-high pressures, Gaspac seals are driving innovation, achieving ever-greater pressures. This gas-lubricated, dry-running seal employs some of the most advanced non-contacting, lift-off technology available. It also boasts unequalled reliability, outlasting multiple compressor turnaround cycles.



GAS SUPPORT SYSTEM

Supplypac

Supplypac modular-based dry gas seal support systems simplify the typical dry gas seal control panel and provide safe, reliable seal operation.

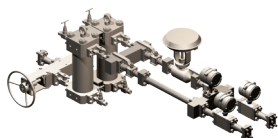

- Supplypac modular-based dry gas seal support systems simplify the typical dry gas seal control panel and provide safe, reliable seal operation.
- Functional qualifications per API 614 design criteria and ASME B31.3 certification
- Wide operating range via flow paths that are scalable for lower pressure, larger bore and higher flow rates
- Ease of installation and improved inventory management from standardization of pre-manufactured components
- Available in multiple material and gasket options to meet specific requirements

SPECIFICATIONS

Press. to: 414 bar (6000 psi)
Temp: to 240°C (400°F)

Refer to literature FSD113
at flowserve.com/library.

GAS SUPPORT SYSTEM

Cleanpac D, F and DL

The Cleanpac line of dry gas seal filtration systems includes heavy liquid removal units (Cleanpac D), pre-filter units (Cleanpac F), as well as single and dual coalescing filter units (Cleanpac DL).



- Lower operational costs and improved dry gas seal system reliability owing to filter elements with efficiency of $B(0.3) > 1000$ (99.9% @ 0.3µm)
- Application versatility due to wide variety of materials of construction (including 316 SS, the standard for onshore and offshore applications) as well as high-temperature and high-pressure designs
- Reduced downtime resulting from a large coalescing element that enables extended operational periods between change-outs

SPECIFICATIONS

Press. to: 550 bar (8000 psi)
Temp: to 204°C (400°F)

Refer to literature FSD113
at flowserve.com/library.

COMPRESSOR SEALS AND SYSTEMS

GAS SUPPORT SYSTEM

Ampliflow



The Ampliflow seal supply gas boosting system ensures an adequate supply of clean, filtered gas is provided to the seals during periods of low differential pressure across the compressor.

- Optimal dry gas seal performance ensured by the system's ability to maintain flow through the conditioning system or seal gas panel
- Lower operating costs made possible by eliminating process contamination — the number one cause of dry gas seal failures
- Versatility via configuration options that include a portable unit, standalone panel, or integration with a Flowserve dry gas seal control panel or filter gas conditioning panel

SPECIFICATIONS

Press. to: 550 bar (8000 psi)
Temp: to 204°C (400°F)

Refer to literature FSD113
at flowserve.com/library.

GAS SUPPORT SYSTEM

Drypac

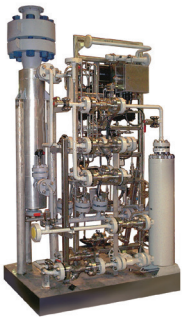

The Drypac gas dryer reduces the potential of liquid formation between the seal faces as a best practice reliability improvement measure and recommended by API standards.

- Decreased liquid formation ensured by system that lowers the dew point of the gas and raises the temperature of the seal supply gas to at least 20°C (36°F) above the dew point
- Increased MTBF of dry gas seals when the dew point of the gas is a potential issue
- Low operating costs due to simplified installation, operation and maintenance
- Easily integrated within existing gas seal control panels

SPECIFICATIONS

Press. to: 550 bar (8000 psi)
Temp: to 204°C (400°F)

Refer to literature FSD113
at flowserve.com/library.

GAS SUPPORT SYSTEM

N2 Genpac

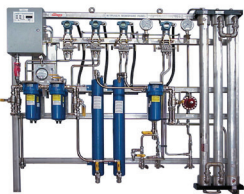

The N2 Genpac system safely generates nitrogen gas from compressed air in hazardous conditions or remote locations.

- Optimal dry gas seal performance ensured by micron fiber filtration technology that extracts nitrogen gas at purities between 97% and 99%
- Uninterrupted nitrogen flow made possible by dual parallel filtration technology
- High uptime provided by monitoring system with differential pressure indicating transmitters and inlet/outlet pressure gauges
- Application flexibility arising from system that can operate independently or integrate with the Flowserve dry gas seal panel or Cleanpac and Drypac gas conditioning systems

SPECIFICATIONS

Press. to: 13 bar (190 psi)
Temp: to 50°C (122°F)

Refer to literature FSD113
at flowserve.com/library.

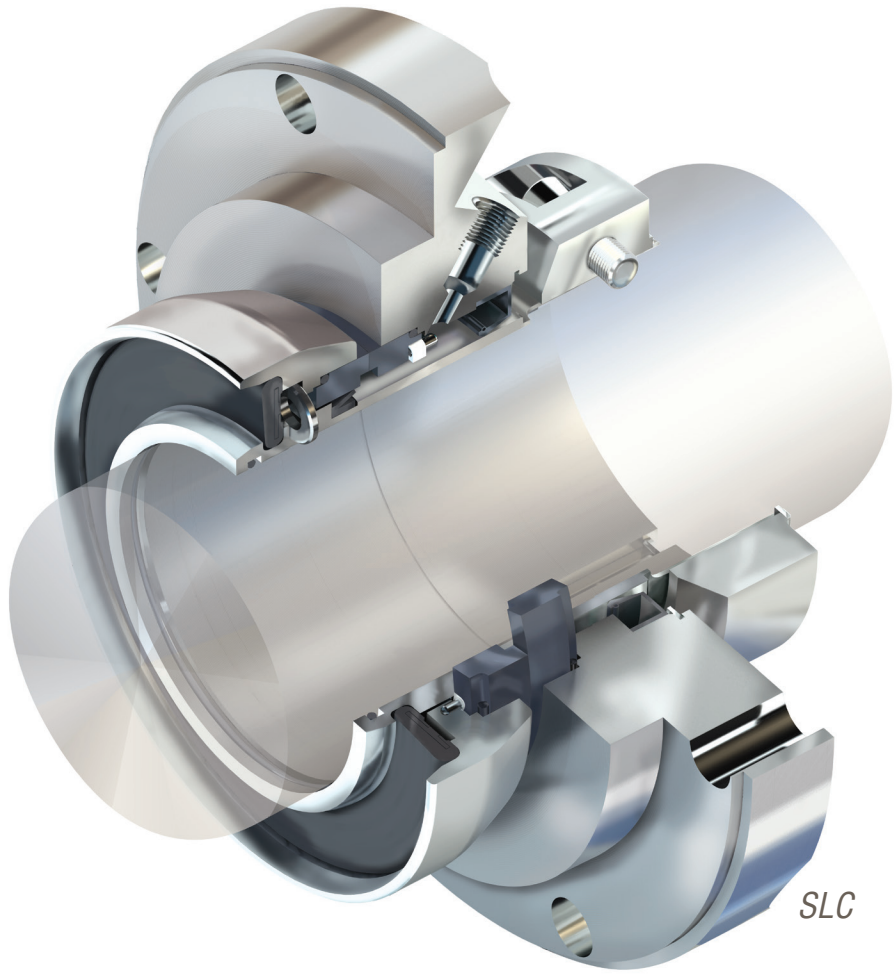

SLC

SLURRY

Abrasive. Erosive. Corrosive. Viscous. Slurry applications can be brutal on equipment, but Flowserve slurry seals are engineered to last. From economical designs for low-solids applications to rugged beasts that handle up to 60% solids content by weight, Flowserve slurry seals resist clogging with smooth geometries and non-wetted springs. Costs are controlled with engineered assemblies that fit common slurry pumps and modular components that make field repair easy. What's more, customers will find unrivaled support in our knowledgeable and experienced engineering and support teams.

Slurry – Quick Reference*

Product	Sub-Type	Pressures	Temperatures	Speeds to	Sizes
SLC Series	Slurry Process	20.6 bar (300 psi)	-18°C to 110°C (10°F to 230°F)	15 m/s (50 fps)	32 to 220 mm (1.250 to 8.661 in)
SLM Series	Slurry Process	17.2 bar (250 psi)	-40°C to 149°C (-40°F to 300°F)	23 m/s (75 fps)	50 to 235 mm (2.000 to 9.250 in)
RIS	Slurry Process	10.3 bar (150 psi)	-4°C to 110°C (25°F to 230°F)	11 m/s (36 fps)	32 to 235 mm (1.250 to 9.250 in)
Allpac	Slurry Process	50 bar (725 psi)	-40°C to 220°C (-40°F to 430°F)	50 m/s (164 fps)	20 to 30 mm (0.750 to 11.750 in)

SLURRY

SLURRY PROCESS

SLC Series

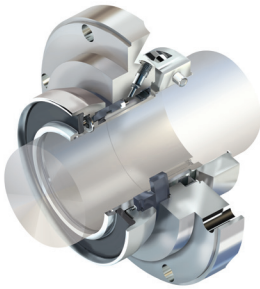

SLC seals are heavy-duty, single pusher cartridge seals built for the harshest slurry pump services found in mining, mineral and ore processing, and flue gas desulfurization. Suitable for solids to 60% by weight.

- Lower operating costs ensured by unique non-clogging, encapsulated cone spring, which increases reliability and enables flushless operation
- Maximized equipment uptime provided by abrasion-resistant metal components and silicon carbide faces that extend seal life beyond that of slurry pump components
- Economical performance via clean, open design, which operates without flush water to reduce product dilution and eliminate flush water costs
- Ease of installation resulting from cartridge design that requires no special tools or bearing housing adjustments

SPECIFICATIONS

Press. to: 20.6 bar (300 psi)
Temp: -18°C to 110°C (10°F to 230°F)
Speeds to: 15 m/s (50 fps)
Sizes: 32 to 220 mm (1.250 to 8.661 in)
Refer to literature FSD120 or FSD103 at flowserve.com/library.

SLURRY PROCESS

SLM Series

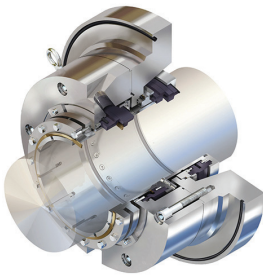

These balanced single (SLM-6000) or dual (SLM-6200) cartridge pusher seals have a flexible stator and operate without outside flush liquid to eliminate product dilution, increase plant efficiency and reduce costs.

- Increased reliability and consistent “no visible leakage” operation due to line-on-line, hydraulically balanced faces
- Extended seal life enabled by centroid-loaded monoblock rotor that helps to maintain zero net deflection, reducing leakage and wear
- Reduced maintenance costs provided by large cross-section stator O-ring, which allows maximum shaft movement while reducing the damaging effects of hang-up
- Dependable performance provided by single seals handling solids to 20%, dual seals to 60% solids, and quench options providing complete application flexibility

SPECIFICATIONS

Press. to: 17.2 bar (250 psi)
Temp: -40°C to 149°C (-40°F to 300°F)
Speeds to: 23 m/s (75 fps)
Sizes: 50 to 235 mm (2.000 to 9.250 in)
Refer to literature FSD166 or FSD103 at flowserve.com/library.

SLURRY PROCESS

RIS

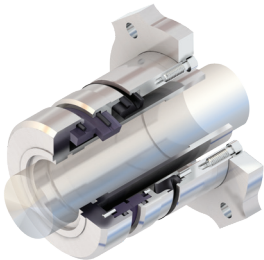

The RIS rubber-energized, component slurry seal features a unique non-clogging design that does not utilize springs or bellows. Handles solids to 50% by weight.

- Ease of installation provided by innovative adaptive components that allow the seal to be installed from the wet end and adjusted externally
- Longer MTBF from non-clogging elastomer spring design that has no dynamic O-ring to hang up
- Reliable operation ensured by the rubber-energized stationary seal face that holds the seal faces together and absorbs relative shaft movement
- Reduced operating costs and improved control made possible by flushless operation, which is especially beneficial in flue gas desulfurization

SPECIFICATIONS

Press. to: 10.3 bar (150 psi)
Temp: -4°C to 110°C (25°F to 230°F)
Speeds to: 11 m/s (36 fps)
Sizes: 32 to 235 mm (1.250 to 9.250 in)
Refer to literature FSD151 or FSD103 at flowserve.com/library.

SLURRY PROCESS

Allpac

This simple yet robust single, balanced cartridge pusher seal is a cost-effective solution for slurry processes with solids to 20% by weight.

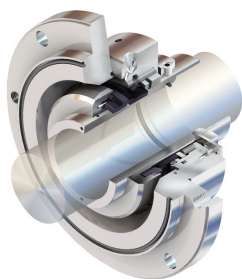

- Increased uptime enabled by springs isolated from the process fluid and large clearances between the seal and shaft seal that prevent clogging
- Reduced operating costs made possible by a design that operates without flush
- Ease of installation from cartridge seal construction
- Broad application flexibility made possible with single- and dual-cartridge arrangements as well as single- and multiple-spring designs

SPECIFICATIONS

Press. to: 50 bar (725 psi)

Temp: -40°C to 220°C (-40°F to 430°F)

Speeds to: 50 m/s (164 fps)

Sizes: 20 to 30 mm (0.750 to 11.750 in)

Refer to literature FSD129 or FSD103 at flowserve.com/library.

The Virtues of Diamond

For improved reliability in applications with poor lubricity, Flowserve offers diamond-coated silicon carbide seal faces. Available across the Flowserve seal platform, Flowserve diamond-coated seal faces provide mechanical properties and performance characteristics that surpass all others. Among the benefits are: improved wear resistance; high thermal conductivity; dry-running tolerance; and low break-out torque. The upsides are significant lifecycle cost savings due to longer mechanical seal run time plus reduced cooling water and energy usage.



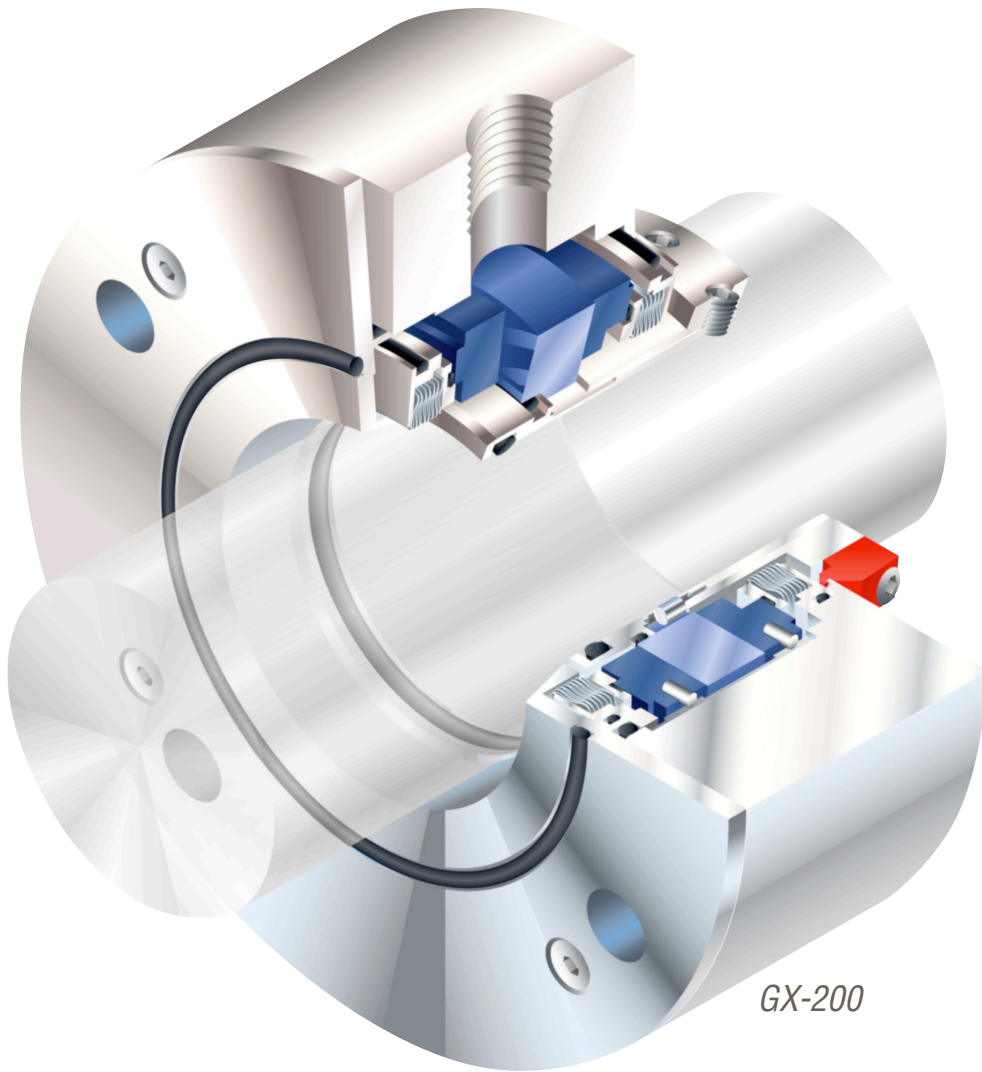

GX-200

GAS BARRIER AND CONTAINMENT

Running a liquid seal dry almost always means trouble, whether it's equipment failure, unwanted downtime or unsafe conditions. Flowserve gas barrier seals have non-contacting seal faces that lift off during operation, so they run safely and reliably, no matter what's happening in the seal chamber. They also use less power and employ simplified support systems. Flowserve containment seals normally run dry as a ready backup behind a liquid-lubricated inboard seal. During upset events, the containment seal takes over primary sealing responsibilities until the equipment can be safely serviced. Both designs offer significant cost and environmental advantages, either minimizing or eliminating emissions.

Gas Barrier and Containment – Quick Reference

Product	Sub-Type	Pressures to	Temperatures	Speeds	Sizes
GF-200	Industrial Process	34.5 bar (500 psi)	-40°C to 260°C (-40°F to 500°F)	1.3 to 25 m/s (4 to 82 fps)	25.4 to 152 mm (1.000 to 6.000 in)
GX-200	Industrial Process	13.8 bar (200 psi)	-40°C to 260°C (-40°F to 500°F)	2.5 to 35 m/s (8 to 115 fps)	25.4 to 76.2 mm (1.000 to 3.000 in)
GSL	API Process	41.4 bar (600 psi)	-40°C to 204°C (-40°F to 400°F)	1.5 to 30.5 m/s (5 to 100 fps)	20.6 to 152 mm (0.813 to 6.000 in)
GSDH	API Process	20.7 bar (300 psi)	-73°C to 427°C (-100°F to 800°F)	to 19.8 m/s (57 fps)	28.2 to 128.9 mm (1.110 to 5.073 in)
GTSP	API Process	17.2 bar (250 psi)	-73°C to 427°C (-100°F to 800°F)	3 to 46 m/s (10 to 150 fps)	47.6 to 104.8 mm (1.875 to 4.125 in)

GAS BARRIER AND CONTAINMENT

INDUSTRIAL PROCESS

GF-200

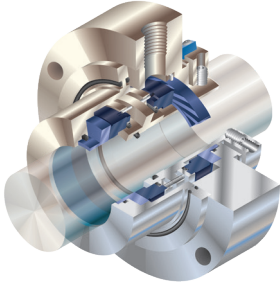

This dual pressurized non-contacting, gas barrier pusher seal is used in applications where zero emissions of hazardous pumped products can be tolerated.

- Environmental regulatory compliance assured by inert gas barrier that operates with zero process emissions
- Greater reliability enabled by spring energized O-ring technology to maintain proper seal face tracking
- Longer service life from silicon carbide seal faces using APG precision face topography, which creates a stiff, thin gas film that prevents wear
- Economical performance via non-contacting seal faces that require very low power consumption during startup and operation

SPECIFICATIONS

Press. to: 34.5 bar (500 psi)
Temp: -40°C to 260°C (-40°F to 500°F)
Speeds: 1.3 to 25 m/s (4 to 82 fps)
Sizes: 25.4 to 152 mm
(1.000 to 6.000 in)

Refer to literature FSD137
at flowserve.com/library.

INDUSTRIAL PROCESS

GX-200

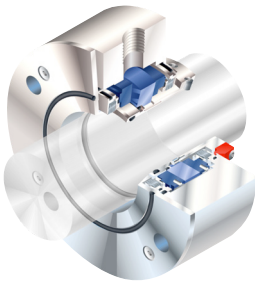

GX-200 dual metal bellows seals utilize APG non-contacting seal face technology for outstanding performance in a variety of applications. Fits standard or small bore seal chambers without modifications.

- Environmental regulatory compliance assured by inert gas barrier that operates with zero process emissions
- Long-term reliability provided by high alloy metal bellows that resist contamination and hang-up while providing pressure reversal product containment during upset events
- Lower operation and maintenance costs provided by unique design that eliminates the costs of maintaining a liquid barrier system and the risks of barrier fluid contamination
- Economical performance enabled by energy-efficient design that delivers the industry's lowest power consumption for conventional pumps

SPECIFICATIONS

Press. to: 13.8 bar (200 psi)
Temp: -40°C to 260°C (-40°F to 500°F)
Speeds: 2.5 to 35 m/s (8 to 115 fps)
Sizes: 25.4 to 76.2 mm
(1.000 to 3.000 in)

Refer to literature FSD105
at flowserve.com/library.

API PROCESS

GSL

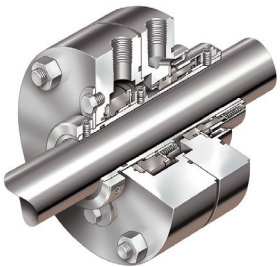

GSL non-contacting gas seals are designed for dry running vapor containment and full pressure wet backup sealing in light hydrocarbon, crude oil and hazardous services.

- Fully compliant with API 682 Type A, Arrangement 2 containment seal requirements
- Greater reliability and service life assured by silicon carbide seal face with a bi-directional wave pattern that provides the lift necessary for non-contacting operation
- Improved plant and personnel safety from backup sealing capability to 600 psi (41.4 bar), allowing safe shutdown if primary seal fails
- Faster, trouble-free startup via cartridge assembly that simplifies installation
- Meets environmental emission limits with available nitrogen sweep auxiliary system

SPECIFICATIONS

Press. to: 41.4 bar (600 psi)
Temp: -40°C to 204°C (-40°F to 400°F)
Speeds: 1.5 to 30.5 m/s
(5 to 100 fps)
Sizes: 20.6 to 152 mm
(0.813 to 6.000 in)

Refer to literature FSD143
at flowserve.com/library.

API PROCESS

GSDH



GSDH seals are dry-running metal bellows containment seals for high-temperature hydrocarbons, heat transfer fluids, and other fluids pumped beyond the temperature limits of elastomers.

- Fully compliant with API 682 Type C, Arrangement 2 containment seal requirements
- Simplified maintenance compared to liquid buffer or barrier fluid dual seals; low-pressure steam or nitrogen purge gas helps achieve near-zero emission levels
- Greater reliability via high alloy rotating metal bellows that clear convolutions and prevent accumulation of debris
- Improved safety with spring-energized graphite gasket that seals with minimal seal face distortion and offers outstanding chemical compatibility

SPECIFICATIONS

Press. to: 20.7 bar (300 psi)

Temp: -73°C to 427°C

(-100°F to 800°F)

Speeds: to 19.8 m/s (57 fps)

Sizes: 28.2 to 128.9 mm

(1.110 to 5.073 in)

Refer to literature FSD260 at flowserve.com/library.

API PROCESS

GTSP

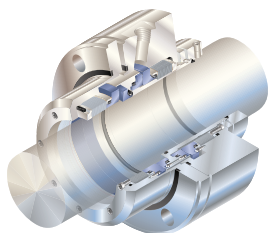

This dual pressurized, high-temperature metal bellows gas seal is engineered for the hottest process pumps found in refinery and hydrocarbon services. Qualification tested per API 682 Type C, Arrangement 3 requirements.

- Increased reliability and service life at lower cost from design that eliminates process leakage and coking problems while avoiding liquid barrier seal issues
- Lower operating costs with laser-applied precision face topography technology, creating a gas film barrier for non-contacting, low-drag, low-energy consumption
- High-temperature performance enhanced by design engineered to operate without cooling and tolerate high axial overtravel during warm-up or thermal transients
- Simplified installation on double-ended pumps via sinusoidal waves, allowing bi-directional operation

SPECIFICATIONS

Press. to: 17.2 bar (250 psi)

Temp: -73°C to 427°C

(-100°F to 800°F)

Speeds: 3 to 46 m/s (10 to 150 fps)

Sizes: 47.6 to 104.8 mm

(1.875 to 4.125 in)

Refer to literature FSD241 at flowserve.com/library.

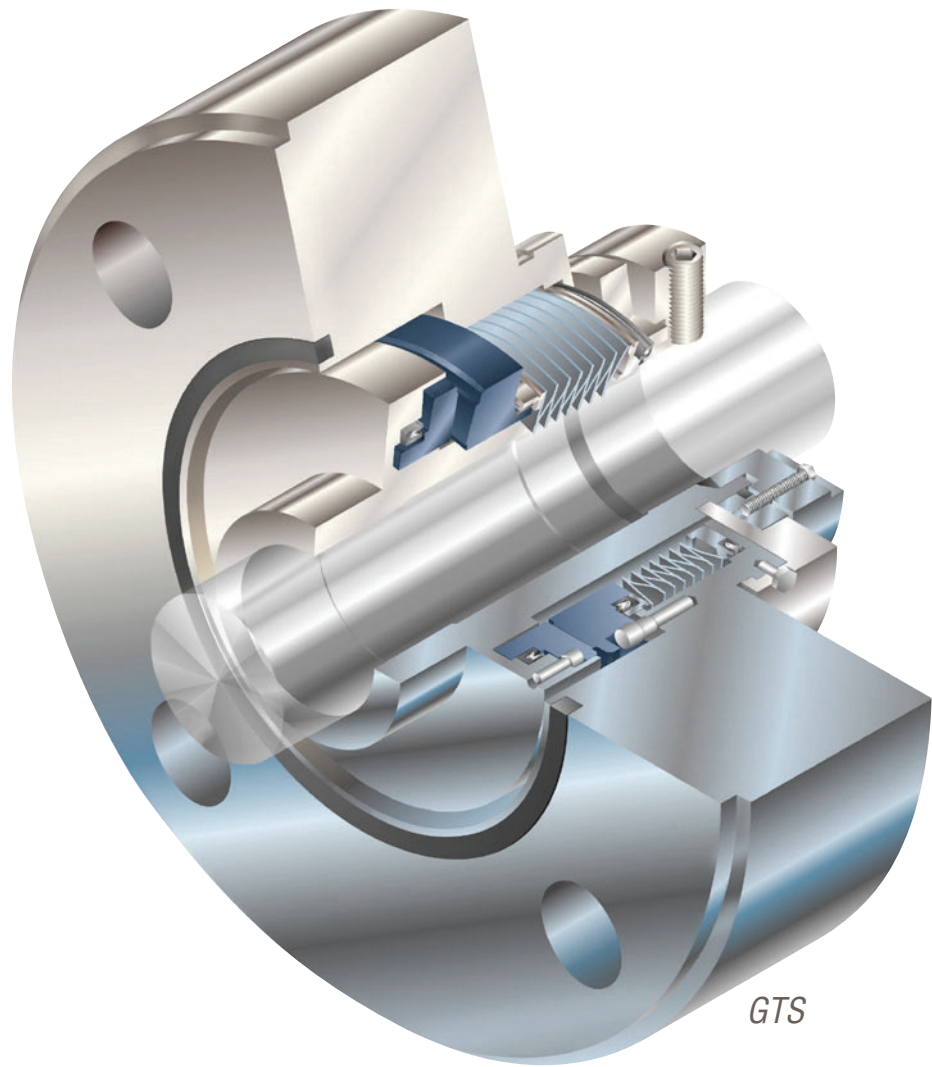

GTS

OEM AND SPECIAL DUTY

Flexibility, reliability and low total cost are fundamental to the general industrial and specialty equipment requirements of OEMs. And Flowserve delivers. Global OEM customers will find a variety of mechanical seals developed specifically with OEMs in mind. That means seals for just about anything: seals for a high-speed, high- pressure integrally geared pump; special configurations for a low- speed, high- viscosity positive displacement pump; and much more. We can even help with custom designs. Reach out to our experienced team.

OEM and Special Duty – Quick Reference

Product	Sub-Type	Pressures	Temperatures	Speeds	Sizes
Pac-Seal®	Industrial Process	to 27 bar (400 psi)	-40°C to 204°C (-40°F to 400°F)	to 25 m/s (83 fps)	15.8 to 150 mm (0.625 to 6.000 in)
PL Series	Industrial Process	Vacuum to 10.3 bar (150 psi)	-18°C to 150°C (0°F to 300°F)	to 23 m/s (60 fps)	35 to 53 mm (1.375 to 2.750 in)
PSS 4	Industrial Process	Vacuum to 30 bar (450 psi)	-18°C to 121°C (0°F to 250°F)	to 19.3 m/s (3800 fpm)	38 to 152 mm (1.500 to 6.000 in)
LS-300	High-Viscosity Process	to 10.3 bar (150 psi)	-53°C to 149°C (-65°F to 300°F)	to 3.5 m/s (12 fps)	19.1 to 76.2 mm (0.750 to 3.000 in)
GTS	Steam Turbines	to 20.7 bar (300 psi)	100°C to 343°C (212°F to 650°F)	3 to 46 m/s (10 to 150 fps)	54 to 181 mm (2.125 to 7.125 in)
GSS	Specialty Equipment	to 86.2 bar (1250 psi)	-62°C to 204°C (-80°F to 400°F)	1500 to 36 000 rpm	25.4 to 31.8 mm (1.000 to 1.250 in)
GLS	Specialty Equipment	to 86.2 bar (1250 psi)	-62°C to 204°C (-80°F to 400°F)	1500 to 36 000 rpm	25.4 to 31.8 mm (1.000 to 1.250 in)
GSG	Specialty Equipment	to 17.2 bar (250 psi)	-40°C to 204°C (-40°F to 400°F)	1500 to 36 000 rpm	to 31.8 mm (1.250 in)
Circpac MD	Specialty Equipment	Vacuum to 6.9 bar (100 psi)	-40°C to 593°C (-40°F to 1100°F)	to 46 m/s (150 fps)	25.4 to 457 mm (1.000 to 18.000 in)
Bulk-Tite™	Specialty Equipment	Vacuum to 3.3 bar (50 psi)	0°C to 121°C (32°F to 250°F)	16.6 m/s (54 fps)	12 to 152 mm (0.500 to 6.000 in)

OEM AND SPECIAL DUTY

INDUSTRIAL PROCESS

Pac-Seal

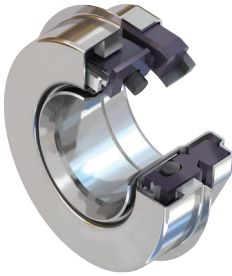

The Pac-Seal family of component seals is available in numerous designs and styles, including diaphragm elastomer bellows to fit a wide range of standard industrial and custom equipment applications.

- Low cost of ownership enabled by readily available components with multiple material options
- Excellent reliability ensured by standardized features, including crimped-head rotary units and hex-torque drive
- Easy installation with no set screws or setting clips
- Custom designs with flexible inventory, logistics and packaging solutions for high-volume OEM orders ensure the right supply requirements are fully achieved

SPECIFICATIONS

Press. to: 27 bar (400 psi)
Temp: -40°C to 204°C (-40°F to 400°F)
Speeds to: 25 m/s (83 fps)
Sizes: 15.8 to 150 mm
(0.625 to 6.000 in)

Refer to literature FSD258
at flowserve.com/library.

INDUSTRIAL PROCESS

PSS 4

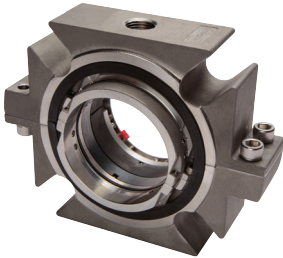

The PSS 4 semi-cartridge split seal is ideal for pump and mixer applications. With only two major components, it makes installation quick and easy without requiring equipment teardown.

- Exclusive 3D Key technology assures optimum face alignment in both axial and radial direction, reducing leakage and installation time
- Unique setting tabs eliminate all seal positioning, measuring and marking, assuring installation success
- Easily handles mixer equipment runout up to 1.5 mm (0.060 in) TIR radial shaft movement
- Fully split design installs easily around the shaft, outside the seal chamber, eliminating the need to dismantle the equipment

SPECIFICATIONS

Press.: Vacuum to 30 bar (450 psi)
Temp: -18°C to 121°C (0°F to 250°F)
Speeds: to 19.3 m/s (3800 fpm)
Sizes: 38 to 152 mm
(1.500 to 6.000 in); contact
Flowserve for larger sizes

Refer to literature FSD272
at flowserve.com/library.

INDUSTRIAL PROCESS

PL Series

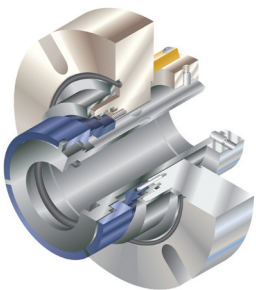

PL Series seals are pre-engineered single (PL-100) and dual (PL-200) cartridge seals with non-metallic wetted components. They are a cost-effective alternative to high-alloy seals in ASME and ISO pumps in corrosive services.

- Greater reliability from special carbon fiber reinforced PTFE construction that provides excellent corrosion resistance and mechanical properties to maintain seal integrity
- Longer service life and MTBF ensured by springs and pins that are isolated from the product to prevent clogging and chemical attack
- Reduced maintenance costs with replaceable carbon fiber PTFE liner that protects the 316 SS gland
- Affordable alternative to high-alloy single or dual metal seals

SPECIFICATIONS

Press.: Vacuum to 10.3 bar (150 psi)
Temp: -18°C to 150°C (0°F to 300°F)
Speeds: to 23 m/s (60 fps)
Sizes: 35 to 53 mm (1.375 to 2.750 in)

HIGH-VISCOSITY PROCESS

LS-300

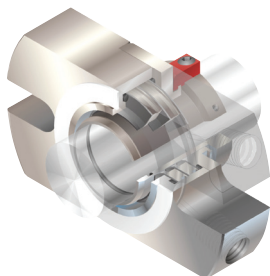

This cartridge-style, multiple dynamic lip seal is designed for highly viscous applications in positive displacement and progressive cavity pumps.

- Greater process accuracy from seal designed to run dry, without the need for an external flush or lubricating barrier fluid
- Reliable operation ensured by triple-lip design effectively seals process from atmosphere at viscosities up to 12 000 cP
- Installation ease assured by preset cartridge
- Application flexibility enabled by design that is interchangeable between standard and universal bracket pumps with just a gasket change
- Ease of field maintenance made possible by optional repair kit

SPECIFICATIONS

Press. to: 10.3 bar (150 psi)
 Temp: -53°C to 149°C (-65°F to 300°F)
 Speeds to: 3.5 m/s (12 fps)
 Sizes: 19.1 to 76.2 mm
 (0.750 to 3.000 in)

Refer to literature FSD117
 at flowserve.com/library.

STEAM TURBINES

GTS

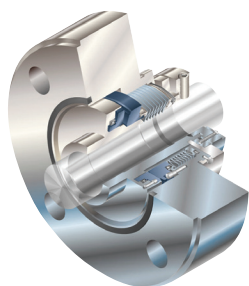

The most reliable steam seal in the industry, the GTS is a metal bellows seal designed to bring the benefits of mechanical seals to steam turbines and handle slow roll operation.

- Significant energy savings and improved safety made possible by design that replaces carbon rings on steam turbines, significantly reducing steam leakage
- Greater reliability through precision face topography technology, ensuring non-contacting, non-clogging operation able to recover from upset conditions
- Long-lasting, high-temperature and corrosive environment performance enabled by Alloy 718 bellows
- Application versatility enabled by internal or external cartridge design, adaptable for diverse turbines

SPECIFICATIONS

Press. to: 20.7 bar (300 psi)
 Temp: 100°C to 343°C (212°F to 650°F)
 Speeds: 3 to 46 m/s (10 to 150 fps)
 Sizes: 54 to 181 mm (2.125 to 7.125 in)

Refer to literature FSD107
 at flowserve.com/library.

SPECIALTY EQUIPMENT

GSS

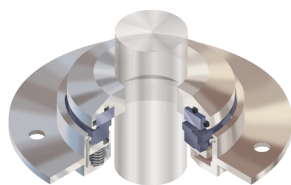

GSS gas-lubricated, non-contacting pusher seals provide superior reliability in high-speed, integrally geared pumps and compressors.

- Longer service life and MTBF enabled by non-contacting precision face topography, eliminating wear at near-zero power consumption
- Installation ease for startup success is provided by a standardized cartridge with a non-clamped rotating face mounted for high-speed performance
- Meets all requirements for low emission containment seals in hydrocarbon pumping applications
- Configurable as a single compressor seal, dual pressurized barrier gas seal, or dry-running containment seal

SPECIFICATIONS

Press. to: 86.2 bar (1250 psi)
 Temp: -62°C to 204°C (-80°F to 400°F)
 Speeds: 1500 to 36 000 rpm
 Sizes: 25.4 to 31.8 mm
 (1.000 to 1.250 in)

Refer to literature FSD102
 at flowserve.com/library.

OEM AND SPECIAL DUTY

SPECIALTY EQUIPMENT

GLS

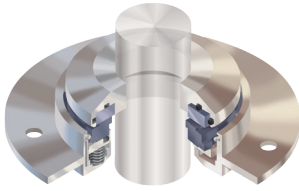

The GLS is the liquid service configuration of the Flowserve GSS. It is designed to fit the unique installation envelop and operating speeds present in integrally geared pumps.

- High-pressure performance enabled by successful operation up to 86.2 bar (1250 psi) in flashing hydrocarbons
- Longer service life assured by operation with no measureable face wear or worn taper due to enhanced seal face flatness provided by the non-clamped rotating SiC face
- Meets all requirements for low emission seals in hydrocarbon pumping applications
- Configurable as a single seal, dual unpressurized seal with liquid buffer, dual unpressurized seal with gas buffer, or dual pressurized seal with liquid barrier

SPECIFICATIONS

Press. to: 86.2 bar (1250 psi)
Temp: -62°C to 204°C (-80°F to 400°F)
Speeds: 1500 to 36 000 rpm
Sizes: 25.4 to 31.8 mm
(1.000 to 1.250 in)

Refer to literature FSD102
at flowserve.com/library.

SPECIALTY EQUIPMENT

GSG

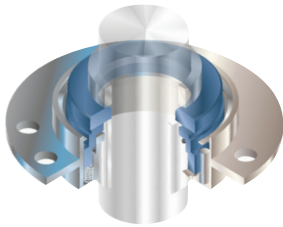

GSG seals are specifically designed for integrally geared pumps and compressors in high-speed, oil-flooded gearbox applications.

- Energy savings and improved safety enabled by innovative Hydrodynamic Surface Tension (HST) face topography that provides near-zero leakage performance
- Reliable high-speed operation enabled by proprietary laser-machined wavy face
- Greater durability and service life assured by seal face materials suitable for frequent starts and stops
- Upgrade ease made possible by direct replacement of existing gearbox seals without equipment modification

SPECIFICATIONS

Press. to: 17.2 bar (250 psi)
Temp: -40°C to 204°C (-40°F to 400°F)
Speeds: 1500 to 36 000 rpm
Sizes to: 31.8 mm (1.250 in)

Refer to literature FSD102
at flowserve.com/library.

SPECIALTY EQUIPMENT

Circpac MD

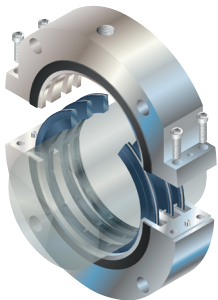

The Circpac MD is a segmented circumferential seal designed for fans, blowers, dryers, turbines, centrifuges and other rotating equipment.

- Superior performance with lower gas consumption ensured by hydraulically balanced ring design that consistently outperforms packing, bushings, labyrinths and felt seals
- Installation ease with radially split seal housing that mounts outside the seal chamber without modification or dismantling
- Increased durability provided by robust carbon rings with foul-resistant joints and large bearing pads that maintain integrity during off-design operation
- Application flexibility with multiple ring configurations that can be staged for reduced leakage, pressurized for zero process emissions, or added for emergency backup

SPECIFICATIONS

Press.: Vacuum to 6.9 bar (100 psi)
Temp: -40°C to 593°C
(-40°F to 1100°F)
Speeds to: 46 m/s (150 fps)
Sizes: 25.4 to 457 mm
(1.000 to 18.000 in)

Refer to literature FSD195
at flowserve.com/library.

SPECIALTY EQUIPMENT

BulkTite

Designed for rotating equipment handling powder and bulk solids, BulkTite seals improve sealing performance with non-wearing, low-maintenance solutions for screw conveyors, rotary airlocks, mixers, de-lumpers and more.



- Easy cartridge seal installation, minimizing downtime
- Superior seal life with 3.2 mm (0.125 in) radial shaft movement, up to 2° angular misalignment and axial shaft movement
- Minimal gas consumption for reduced operating costs

SPECIFICATIONS

Press. to: Vacuum to 3.3 bar (50 psi)

Temp: 0°C to 121°C (32°F to 250°F)

Speeds to: 16.6 m/s (54 fps)

Sizes: 12 to 152 mm
(0.500 to 6.000 in)

Refer to literature FSD267
at flowserve.com/library.

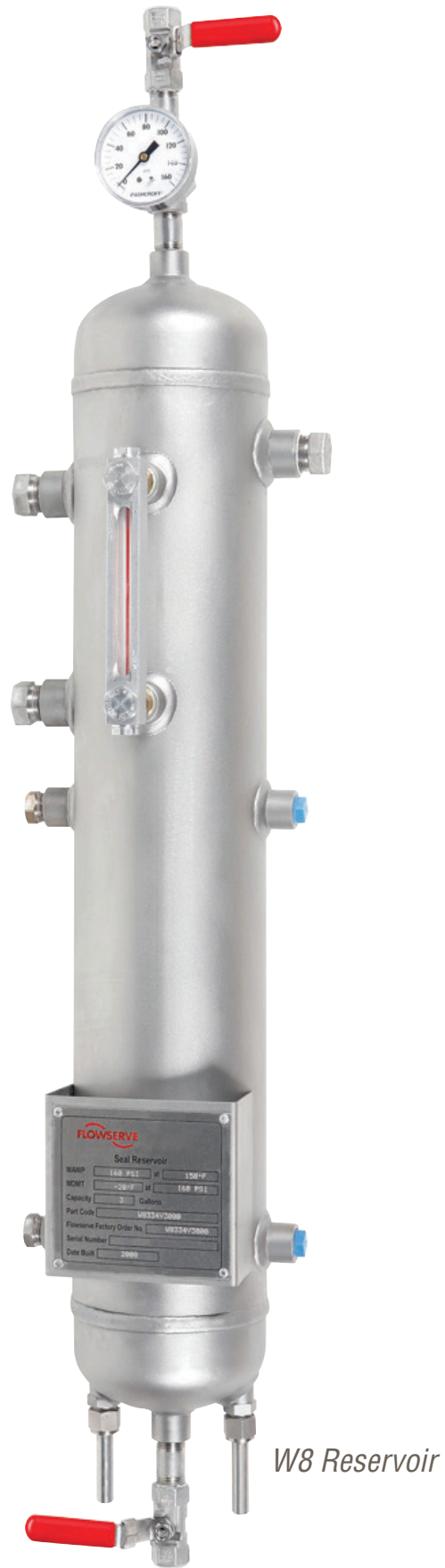

SEAL SUPPORT SYSTEMS

Flowserve seal support systems help ensure years of safe, reliable and cost-effective mechanical seal operation. Flowserve employs a specialized engineering team with years of experience recommending or designing systems to suit specific applications, specifications and unique customer requirements. With a full range of products that meet ASME Section VII Division 1, API, PED, NR13 and numerous other regional and international standards, Flowserve fulfills the global needs of the oil and gas, chemical, power, water and general industries.

Seal Support Systems – Quick Reference

Product Type	Sub-Type	Flows to	Pressures	Temperatures	Volume
Buffer/Barrier Fluid Reservoirs	Industrial & API Process	—	to 82.3 bar (1200 psi)	to 148°C (300°F)	to 20 L (5 gal)
Bladder Accumulators	Industrial & API Process	—	to 82.3 bar (1200 psi)	to 148°C (300°F)	20 to 50 L (5 to 13 gal)
Piston Accumulators	Industrial & API Process	—	to 75.8 bar (1100 psi)	to 148°C (300°F)	to 11.4 L (3 gal)
Buffer/Barrier Gas Panels	Industrial & API Process	14.2 lpm (30 SCFH)	to 34.4 bar (500 psi)	to 93°C (200°F)	—
Circulators	Industrial & API Process	15 lpm (4 gpm)	to 27.6 bar (400 psi)	4.4°C to 60°C (40°F to 140°F)	—
682 Water Seal Coolers	API Process	—	to 275 bar (4000 psi) to 371°C (700°F) (coil)	—	—
Water Seal Coolers	Industrial Process	—	to 183 bar (2650 psi) to 95°C (200°F)	—	—
Airfin Seal Cooler	Industrial Process	—	to 80 bar (1200 psi)	to 425°C (800°F)	—

SEAL SUPPORT SYSTEMS

INDUSTRIAL & API PROCESS

Buffer/Barrier Fluid Reservoirs

Flowserve reservoirs are available for dual pressurized (Plan 53A) and dual non-pressurized (Plan 52) mechanical seals. Options are available for utilizing water or oil as barrier fluid.



- Extended seal life made possible by reliable supply of clean buffer/barrier fluid for cooling and lubrication
- Reduced maintenance and operating costs with optimal buffer/barrier fluid management
- Increased reservoir life with corrosion-resistant 304, 316 or 316L construction
- Compliance with API 682, ASME Section VIII, ASME B31.3, PED and/or TRD as required
- Application flexibility provided by configurations and instrumentation that are easily adapted to local standards as well as application and customer requirements

SPECIFICATIONS

Press: to 82.3 bar (1200 psi)

Temp: to 148°C (300°F)

Volume: to 20 L (5 gal)

Refer to literature FSD239 at flowserve.com/library.

INDUSTRIAL & API PROCESS

Bladder Accumulators

Plan 53B barrier systems are available with multiple options for accumulator sizes, coolers and piping. Compliant with API 682, ASME Section VIII, ASME B31.3, PED and/or TRD as required.



- Increased seal life at higher barrier seal pressures
- Improved reliability by preventing nitrogen entrainment in the barrier fluid
- Ease of installation provided by design that does not require connection to a plant nitrogen utility
- Application flexibility provided by configurations and instrumentation that are easily adapted to local standards as well as application and customer requirements
- Improved reliability made possible by the ability to monitor each seal individually

SPECIFICATIONS

Press: to 82.3 bar (1200 psi)

Temp: to 148°C (300°F)

Volume: 20 to 50 L (5 to 13 gal)

INDUSTRIAL & API PROCESS

Piston Accumulators

Flowserve Plan 53C piston accumulators can be built with multiple options for cooling coils, external heat exchanges and instrumentation to fit customer requirements. Compliant with ASME or PED as required.



- Improved seal life and reliability ensured by tracking barrier pressure where pump pressure fluctuates or the inboard seal pressure differential must be limited
- Lower operating costs from maintenance and barrier fluid cost savings
- Application flexibility provided by configurations and instrumentation that are easily adapted to local standards as well as application and customer requirements

SPECIFICATIONS

Press: to 75.8 bar (1100 psi)

Temp: to 148°C (300°F)

Volume: to 11.4 L (3 gal)

INDUSTRIAL & API PROCESS

Buffer/Barrier Gas Panels

Flowserve Plan 72 and 74 gas panels combine flow monitoring and control elements in a self-contained, easy-to-use unit. For use with unpressurized and pressurized Flowserve gas seals.



- Maximized seal life enabled by supply of clean barrier or buffer gas at optimal conditions
- Compliance with API 682, ASME B31.3 and PED requirements
- Low installation and commissioning costs assured by easy-to-install, self-contained units

SPECIFICATIONS

Flows to: 14.2 lpm (30 SCFH)
Press to: 34.4 bar (500 psi)
Temp: to 93°C (200°F)

INDUSTRIAL & API PROCESS

Circulators

Plan 54 circulators provide clean barrier fluid at a controlled flow rate, pressure and temperature to ensure proper seal performance.



- Optimized seal operating temperatures ensured by maximum system cooling
- Improved seal reliability with a dependable local system, eliminating the need to connect to a distant and potential unreliable pressure source
- Extended seal life enabled by improved system cleanliness that is maintained using one or more high-quality, full-flow liquid filters
- Application flexibility provided by configurations and instrumentation that are easily adapted to local standards as well as application and customer requirements

SPECIFICATIONS

Flows: to 15 lpm (4 gpm)
Press: to 27.6 bar (400 psi)
Temp: 4.4°C to 60°C (40°F to 140°F)

Refer to literature FSD122 at flowserve.com/library.

API PROCESS

682 Water Seal Coolers

Flowserve seal coolers are engineered for high-temperature refinery applications and maximized cooling capacity. Two designs available: the full-featured 682 Seal Cooler and the lower-duty LD 682 Seal Cooler.



- Process control ensured by design that isolates the process fluid from the cooling water
- Ease of commissioning with full vent and drain on both product and coolant sides
- Ease of maintenance provided by ability to quickly and easily disassemble and clean the unit without damaging the coils
- Cost-effective application flexibility with multiple corrosion-resistant material options for the coil and shell construction

SPECIFICATIONS

Press: to 275 bar (4000 psi) (coil)
Temp: 371°C (700°F) (coil)

Refer to literature FSD106 and FPD238 at flowserve.com/library.

SEAL SUPPORT SYSTEMS



INDUSTRIAL PROCESS

Water Seal Cooler

Water seal coolers lower the temperature of process/barrier fluid to improve seal reliability. Designed and manufactured in accordance with ASME Section VIII, Div 1 and PED.

- Easy installation in limited spaces due to compact design with integral mounting bracket and convenient pipe porting
- Simplified maintenance with quick access to coil, only one bolt fastening the shell, and no disturbance to piping during shell removal
- High-temperature fittings included as standard

SPECIFICATIONS

Press: to 183 bar (2650 psi)
to 95°C (200°F)

Refer to literature FSD174
at flowserve.com/library.



INDUSTRIAL & API PROCESS

Airfin Seal Cooler

The Airfin seal cooler is available in natural convection and forced air designs with a cooling area of 2.5 m² (26.8 ft²).

- Lower operating costs ensured by air-cooling technology that eliminates water treatment and disposal
- Improved reliability with cooling water-free design, which prevents accidental shutoff and winter freeze-up
- Minimal installation and maintenance costs with unit design that requires less piping and is less susceptible to fouling

SPECIFICATIONS

Press: to 80 bar (1200 psi)
Temp: to 425°C (800°F)

Refer to literature FSD197
at flowserve.com/library.

The Time Value of Service

Every minute of uptime counts. We get it. We're here to help with sealing technologies, systems and services that minimize downtime, improve equipment reliability and reduce operating expenses — one seal at a time or across an entire unit. And, with our global network of Quick Response Centers, you can rest easy knowing support is near, inventory can ship the same day, and engineered seal repairs can be turned around within days, if not hours.





Bearing Gard

ACCESSORIES

Flowserve accessories for mechanical seals and associated equipment help you enhance long-term reliability and safety while minimizing maintenance. Bearing isolators protect bearing housings from environmental contamination for greater equipment longevity and less downtime. DuraClear synthetic lubricants and barrier fluids provide optimal lubrication for mechanical seals and rotating equipment to extend service life by reducing friction and wear. Cyclone and magnetic separators protect seals and other components by removing entrained particulate from the coolant stream. These products are a sample of the most popular accessories for protecting seals, seal support systems and general rotating equipment.

Accessories – Quick Reference

Product Type	Valve Type	Flows to	Pressures	Temperatures	Sizes
Bearing Gard™	Bearing Isolator	—	—	—	23 to 203 mm (0.875 to 8.000 in)
BGM	Bearing Isolator	—	—	—	to 152 mm (6.000 in)
DuraClear™	Industrial Process	—	—	—	—
Refill Cart	Industrial Process	—	to 103 bar (1500 psi)	—	76 L (20 gal)
Seal Gard™	Industrial Process	13 lpm (3.5 gpm)	25 bar (363 psi)	0°C to 100°C (32°F to 212°F)	—
Magnetic Separator	High-Energy Process	15 lpm (4 gpm)	103.4 bar (1500 psi)	to 204°C (400°F)	12.7 to 19 mm (0.500 to 0.750 in)
Cyclone Separator	Slurry Process	57 lpm (0.9 to 15 gpm)	138 bar (2000 psi)	to 455°C (850°F)	12.7 to 19 mm (0.500 to 0.750 in)
SLD	Slurry Process	—	—	to 80°C (175°F)	—

ACCESSORIES

BEARING ISOLATOR

Bearing Gard

Bearing Gard isolators improve rotating equipment reliability by protecting against contamination and improving oil retention. Applied in all industries, they satisfy IP-66, IEEE-841, API 610 and ATEX requirements.



- Increased rotating equipment life enabled by preventing the #1 reason for rotating equipment failure: contamination of bearings and lubrication
- Decreased maintenance costs made possible with design that eliminates shaft wear and fretting common with other isolator designs
- Significantly reduced oil leaks with non-contacting, non-wearing technology
- Lower inventory costs and fewer part numbers to manage, with one design that covers axial movement up to 0.63 mm (0.025 in)
- Reduced lead time with same-day shipping of made-to-order sizes

SPECIFICATIONS

Sizes: 23 to 203 mm
(0.875 to 8.000 in)

Refer to literature FSD257
at flowserve.com/library.

BEARING ISOLATOR

BGM

Utilizing rare earth magnets to keep seal faces closed, the BGM completely isolates the bearing housing from contamination and effectively contains oil mist within the bearing housing.

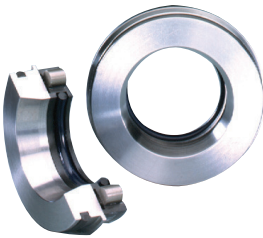

- Increased rotating equipment life enabled by preventing the #1 reason for rotating equipment failure: contamination of bearings and lubrication
- Decreased oil mist lubrication costs with positive sealing, preventing oil mist egress
- Reduced maintenance costs provided by magnets holding the seal faces closed to minimize oil leakage while allowing high axial shaft movement

SPECIFICATIONS

Sizes: to 152 mm (6.000 in)

Refer to literature FSD149
at flowserve.com/library.

INDUSTRIAL PROCESS

DuraClear

DuraClear high-performance synthetic lubricants are specially formulated for dual mechanical seal barrier or buffer fluids to increase mean time between planned maintenance and reduce energy consumption.



- Process fluid compatibility assured by synthetic oils and oil blends readily available with food grade compliance; DuraClear Crystal 7 is chemically inert and non-reactive for the most aggressive services
- Extended seal life with reduced friction and wear, oxidation resistance, temperature stability and low volatility
- Increased drain and replenish intervals due to longer fluid life
- Increased uptime with formulations for bearing frame oil, compressor oil, gear oil, hydraulic oil, turbine oil, air tool lubricant and grease applications

SPECIFICATIONS

NSF H-1 Food Grade
ISO 5, 7 and 32 viscosities
available

Refer to literature FSD123,
FSD269 and FSD268
at flowserve.com/library.



INDUSTRIAL PROCESS

Refill Cart

This rugged, easy-to-use, high-capacity reservoir refill cart allows you to add barrier fluid to seal support systems.

- Reduced maintenance enabled by ability to add barrier fluid during operation, without pump downtime or fugitive emissions
- Reduced errors with optional color-coded quick disconnects to prevent adding incorrect fluid
- Ease of use provided by rugged, easy-to-maneuver cart with pneumatic tires, large reservoir tank and high-pressure hand pump

SPECIFICATIONS

Volume: to 76 L (20 gal)
Press: to 103 bar (1500 psi)



INDUSTRIAL PROCESS

Seal Gard

The Seal Gard manages seal water flow rates for single and dual seals to improve the mean time between planned maintenance of your rotary equipment by improving the environment in the seal area.

- Lower operating cost from dependable flow control that saves water costs by reducing seal water usage
- Ease of operation assured by clear-view acrylic flow meter with vertical flow tube that resists fouling and vibration-resistant pressure gauge
- Reduced downtime enabled by standard check valve that prevents backup of product into the seal water line in the event of pressure reversal

SPECIFICATIONS

Flows to: 13 lpm (3.5 gpm)
Press. to: 25 bar (363 psi)
Temp: 0°C to 100°C (32°F to 212°F)
Refer to literature FSD154
at flowserve.com/library.

HIGH-ENERGY PROCESS

Magnetic Separator

A magnetic separator installed in closed loop fluid systems removes iron oxide particles, protects equipment from contamination damage and increases system reliability.

- Minimal installation costs by inline insertion into Plan 23 piping plans or similar closed loop control lines
- Improved mechanical seal reliability enabled by strong magnetic field that effectively captures iron oxide particles to prevent seal face abrasion, hang-up or clogging
- Long-term reliability provided by large surface area of magnet capable of storing iron oxide particles through extended maintenance cycles

SPECIFICATIONS

Flows: to 15 lpm (4 gpm)
Press. to: 103.4 bar (1500 psi)
Temp: to 204°C (400°F)
Sizes: 12.7 to 19 mm
(0.500 to 0.750 in)

Refer to literature FSD173
at flowserve.com/library.



ACCESSORIES



SLURRY PROCESS

Cyclone Separator

Cyclone separators are designed to efficiently remove sand, pipe scale and other abrasive particles from Plan 31 injection flow to mechanical seals.

- Increased seal reliability ensured by centrifugal effects generated by differential pressure across the cyclone that carries away abrasive particles
- Improved equipment reliability, with up to 99% separation efficiency
- Offered in several sizes to fit the application based on flow rate and pressure

SPECIFICATIONS

Flows to: 57 lpm (0.9 to 15 gpm)
Press. to: 138 bar (2000 psi)
Temp: to 455°C (850°F)
Sizes: 12.7 to 19 mm
(0.500 to 0.750 in)

Refer to literature FSD173
at flowserve.com/library.



SLURRY PROCESS

SLD

The SLD dispenses lubrication to the atmospheric side of mechanical seals. It is ideal for seals subjected to periods of dry running or cavitation when product liquid does not provide adequate film between seal faces.

- Extended seal life — particularly flushless seals in harsh slurry conditions — made possible by providing and maintaining proper lubrication
- Lower operating cost delivered by unitized system that does not require air, electricity or external water
- Increased uptime with DS-920-OG DuraClear lubricant, which resists breakdown when mixed with pumpage, water or containments
- Optional DS-460-F DuraClear lubricant is approved by USDA for incidental food contact

SPECIFICATIONS

Temp: to 80°C (175°F)
Refer to literature FSD148
at flowserve.com/library.



APPENDIX

Basic Design and Operation	72
Design Options	75
Seal Materials	78
Mechanical Seal Piping Plans	80
Index	84



BASIC DESIGN AND OPERATION

Mechanical seals provide the most effective means of sealing rotating equipment, handling process liquids and gases in modern rotating equipment such as centrifugal pumps, compressors, mixers and reactors. The ability to effectively limit or eliminate process fluid from leaking to the environment has made the mechanical seal the default sealing device for the modern industry.

While all seal designs share some common characteristics, the success of an application depends on the proper selection of the seal model, design options, materials, arrangements and piping plans. Flowserve engineers can help provide guidance for the most appropriate seal and sealing system selection for each application.

Seal Anatomy

A mechanical seal in its simplest terms creates a controlled fluid film between a rotating seal face (or rotor) and a stationary seal face (or stator). These seal faces are attached to the rotating shaft and the stationary seal chamber through adaptive hardware such as sleeves and glands. These and other seal components work together to allow the seal to operate on a very thin fluid film between the rotating and stationary seal faces. The thickness of the fluid film is engineered to minimize seal emissions and face wear while maximizing seal life and reliability.

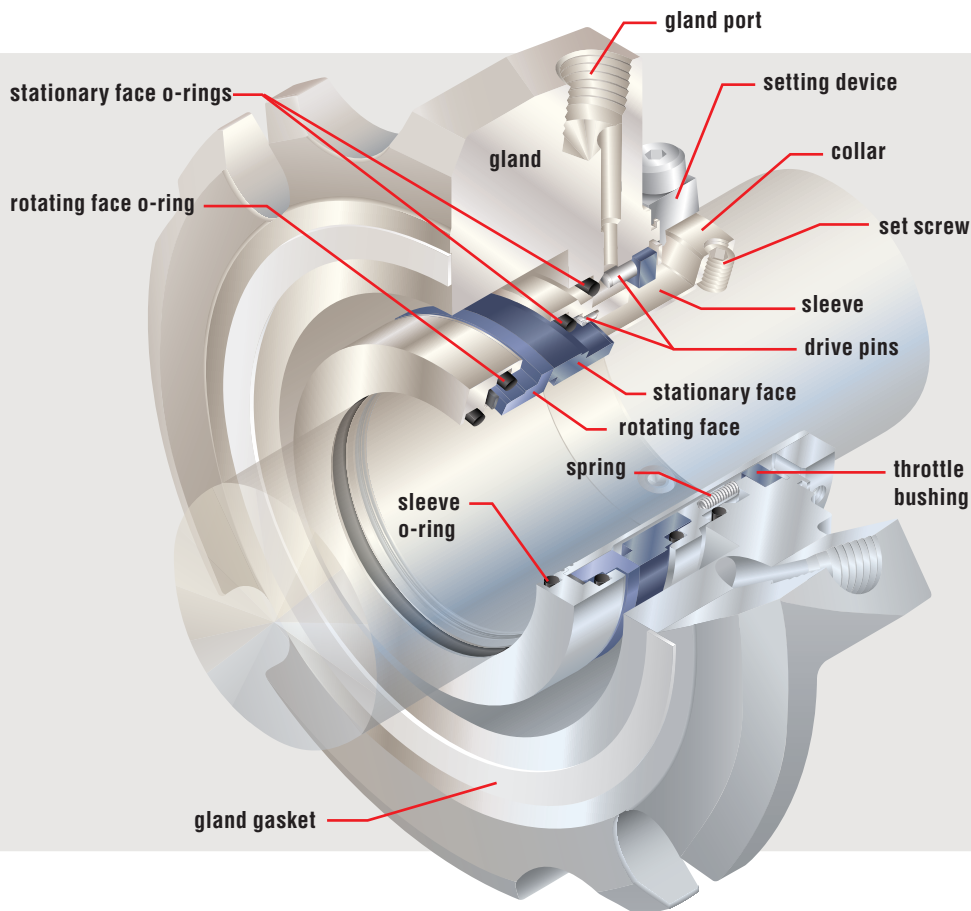

Solutions for Liquid or Gas

Mechanical seals can be designed to operate on liquid, gas or mixed-phase process fluids. In contacting liquid seals, the fluid film provides hydrostatic support as well as lubrication and cooling between the seal faces. The fluid film thickness is typically on the same order of magnitude as the roughness of the seal faces: approximately 0.5 micron or 20 microinches. This results in a light contact between the asperities of the seal faces, allowing for a low coefficient of friction and low wear while minimizing seal emissions. Tribologically, operation in this mixed lubrication regime requires precise control of seal face topography, hydraulic loading, face deformations and material properties. Flowserve has optimized these design factors to create optimum seal performance.

Seal faces are also designed to operate with a gas or vapor film. This expands the ability of a mechanical seal to provide sealing into a wider range of equipment and more demanding operating window. Dry running seal faces are typically designed to operate in a noncontacting mode. Highly engineered features on the seal faces are designed to create a hydrodynamic lift, which effectively separates the seal faces during operation. This results in very low power requirements and allows for operation at higher speeds and pressures.

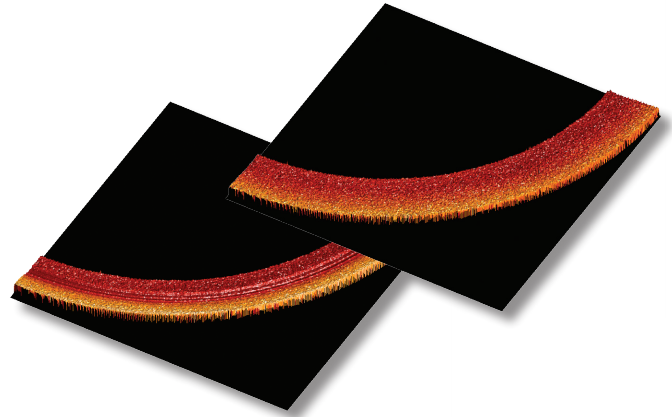

Magnified approximately 2000 times, these three-dimensional images illustrate surface roughness on silicon carbide seal faces. The grooves on the lower image are the result of light asperity contact with a carbon graphite mating face.

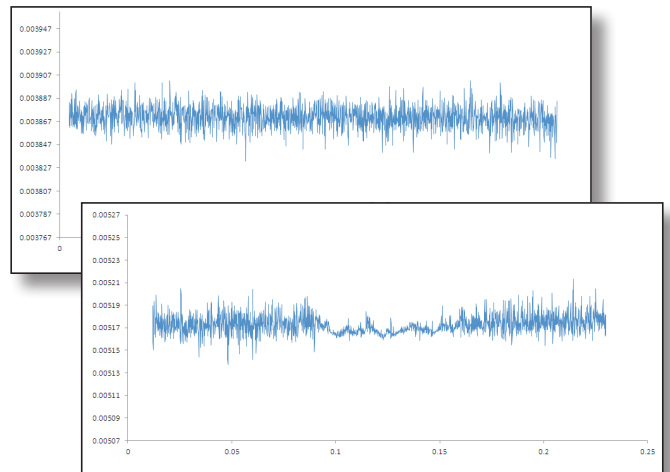

High-resolution, cross-sectional trace of seal face roughness. The top trace is a new face, while the bottom trace illustrates the results of light asperity contact.

Precision Face Topography

Advanced design and manufacturing capabilities have further expanded the ability of mechanical seals to operate in more demanding environments than ever before. The control of the seal face topography and innovative design of microfeatures have redefined the way mechanical seals operate. The sealing interface is no longer restricted to only flat faces. Face features can be designed to enhance the fluid film, create lift, reduce friction, minimize emissions and reduce wear. These features can only be created with sophisticated manufacturing techniques which are capable of providing the accuracy and precision required for these microfeatures. Flowserve has pioneered the use of these techniques in mechanical seal design and manufacturing.



Design and Modeling Capabilities

Flowserve has developed some of the most advanced seal modeling and design capabilities in the world. Analytical techniques including finite element analysis (FEA) and specialized multi-physics models are specifically tailored for the unique characteristics of mechanical seals. The development of new microfeatures and face topography designs have only been possible due to advanced seal modeling capabilities. Seal models are continuously verified and refined through active research and development programs. Better modeling accuracy in the office establishes safer, more reliable mechanical seals in the field.

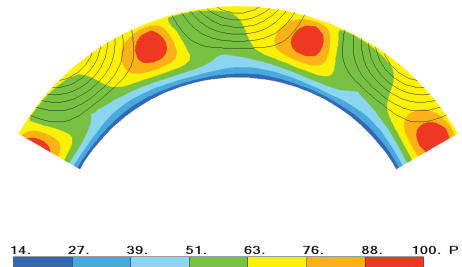
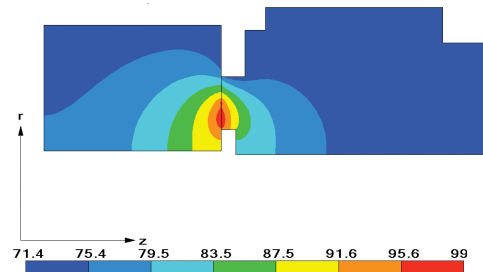

DESIGN OPTIONS

Mechanical seals are available in a wide range of designs and capabilities. This is necessary to provide solutions for the similarly wide range of pump and equipment designs, process conditions and operating requirements demanded by industry.

The selection of the appropriate seal design, design features, seal arrangement and piping plan is critical to achieving the seal performance required by the end user. Seal designs can be categorized by a number of different design features.

Seal Type

Seals are commonly categorized as “pusher seal” and “bellows seal” based on the type of mechanical loading used. A pusher seal consists of two seal faces where the flexible seal face utilizes a dynamic gasket to allow for axial motion and is loaded by mechanical springs. This is the most common seal design. Pusher seals can be designed for application conditions ranging from simple designs for low duties to highly engineered complex designs for very high pressures and speeds.

A bellows seal utilizes a flexible bellows element to allow for axial motion. The bellows element itself is also commonly used to provide mechanical loading for the seal faces. One of the most common bellows seal designs uses an edge-welded metal bellows. These are constructed from corrosion-resistant alloys, which allow their use in harsh chemical environments. Special designs with flexible graphite gasketing are engineered to operate at extreme temperatures. By eliminating the dynamic gasket, bellows seals can be more tolerant of solids or process contamination. Elastomeric bellows designs are also commonly used in lower duty services.

Component pusher seal

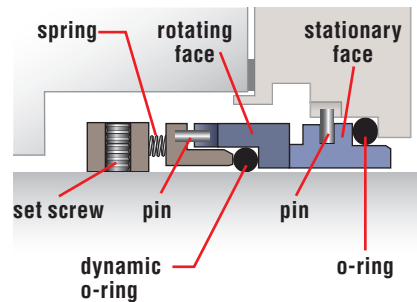

Component metal bellows seal

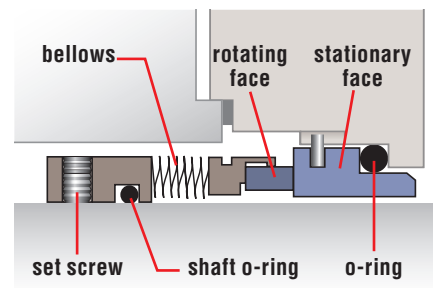

Cartridge and Component Seals

Mechanical seals have historically been offered as both component seals and cartridge seals. A component seal consists of basic seal parts which must be installed into the pump as individual components. This requires significant skills and care to ensure proper installation. A cartridge seal is packaged so that all components are preassembled and can be installed into the pump as a complete assembly. This ensures that all the components are correctly installed and not damaged during installation. Most mechanical seals supplied to industrial users are provided as cartridge seals.

Component pusher seal

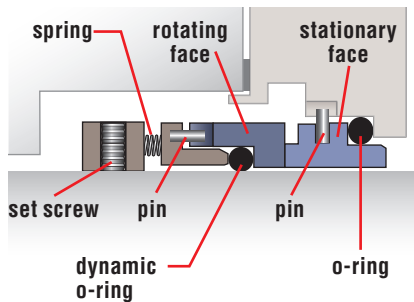

Cartridge pusher seal

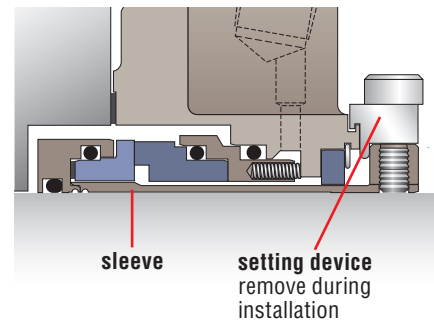

Rotating vs. Stationary Flexible Element

The flexible element (springs or bellows) can be designed so it rotates with the seal sleeve or is stationary with the seal gland. Rotating flexible elements are the most common design and provide for small radial cross-sections and self-cleaning performance. Stationary flexible elements can tolerate higher equipment misalignments and operate at higher speeds. Most sealing applications can be satisfactorily sealed with either design.

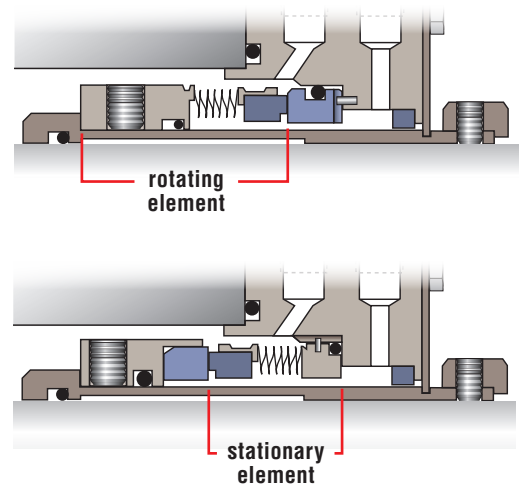

Single and Dual Seals

Most mechanical seal installations have one set of seal faces in the assembly. There are, however, applications where it is beneficial to have multiple seals provide reduced emissions or sealing redundancy. These options are described as seal arrangements.

Arrangement 1 seals are single seals which contain one set of seal faces. This provides for a simple installation, although all leakage goes to the atmospheric side of the seal. Arrangement 2 seals have two sets of seal faces where the cavity between the two seals is maintained at a lower pressure than the seal chamber pressure.

Any leakage past the primary seal is captured in this cavity, which minimizes process exposure to the environment. This dual-seal arrangement also provides sealing redundancy if one seal fails. Arrangement 3 seals have two sets of seal faces where the cavity between the two seals is maintained at a pressure greater than the seal chamber pressure. This has the benefit of eliminating any process leakage to the environment and making the seal less dependent on process conditions. All seal arrangements are commonly used in industry.

Arrangement 1: Single seal

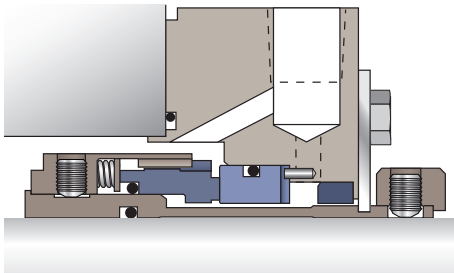

Arrangements 2 and 3: Dual seal

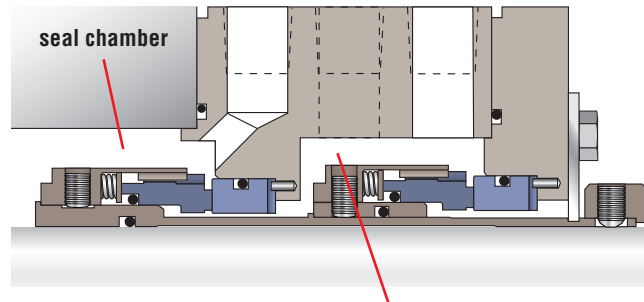

cavity between seals

Arrangement 2: pressure is lower than seal chamber

Arrangement 3: pressure is higher than seal chamber

Operating Window

Seals are designed to operate successfully in a range of operating conditions. No one seal design is capable of operating in every application. For this reason, each seal model has an operating window which defines the applications where the seal is suitable. In some cases, these limits represent mechanical limitations and in other cases, material limitations. This catalog uses the following parameters to define the operating window for a specific seal model: pressure, temperature, speed and size.

While these parameters capture the significant design factors for a seal, the actual application conditions may dictate a different operating window. Fluid properties can change dramatically and will affect the operating window for the seal. For example, lubricating oil at 93°C (200°F) behaves quite differently than water at the same temperature. The selection of materials for an individual component, especially elastomers, may also restrict the operating window. Finally, the combination of all of these factors will dictate the suitability of the seal for an application. The operating window for any mechanical seal will serve as an initial screening for seal selection; however, true suitability can only be determined by a more thorough engineering review.

SEAL MATERIALS

Mechanical seals contain multiple components serving very different functions and require materials ranging from elastomers to ceramics. While these materials have very different properties, they must all work together to provide satisfactory seal performance.

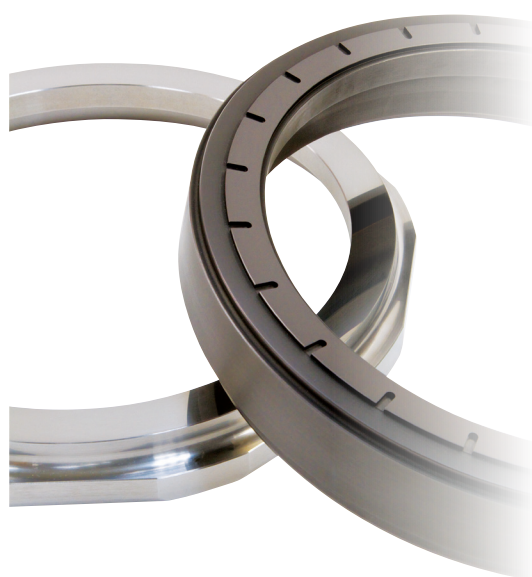

Seal Faces

The seal faces in a mechanical seal are arguably its most critical components and require the greatest care in material selection. Historically, a wide variety of materials have been used from metals and overlays to ceramics and carbons. Advances in seal face materials have greatly enhanced the performance of mechanical seals, for example, diamond-coated silicon carbide adds measurable run time in abrasive and poor-lubricity services. The most common seal face materials are listed below.

Reaction-Bonded Silicon Carbide	General duty hard face material, excellent physical properties, cannot be used in caustics and/or aggressive acids
Sintered Silicon Carbide	General and chemical duty hard face material, excellent physical properties, used in aggressive chemical applications
Nickel-Bound Tungsten Carbide	General duty hard face material, excellent physical properties, impact resistant, limited use in aggressive chemicals
Alumina Oxide	Chemical duty hard face material, excellent chemical resistance, limited to low duty services
Resin-Impregnated Carbon	General duty soft face material, good chemical resistance, good frictional properties
Metallized Carbon	Antimony metal-filled carbon, high duty soft face material, limited chemical resistance, good physical properties, blister resistant
Diamond-Coated Silicon Carbide	General, chemical and slurry duty diamond-coated hard face material, excellent physical properties, superior frictional properties, highest wear resistance

Elastomers and Secondary Seals

The seal face pair in a mechanical seal is called the primary seal, and all other sealing points are referred to as secondary seals. Secondary seals are used throughout mechanical seals. These are most commonly in the form of elastomeric O-rings, although spring-energized gaskets, flat gaskets or formed gaskets are also used. Secondary seals, especially O-rings, are available in all common elastomeric materials such as FKM, FFKM, EPDM and NBR. PTFE-based gaskets and flexible graphite gaskets are used where their unique properties are required. The basic seal design will dictate which materials are available for each seal model.

Metallic Components

A significant number of seal components are manufactured from metallic materials. Metallic components are selected to provide both the physical properties and corrosion resistance required by the application. The default material for most seal components is austenitic stainless steel (Alloy 316), although other higher-alloy metals are commonly available such as Alloy C-276, Alloy 400 and Alloy 20. More exotic alloys such as zirconium, titanium and duplex are also available in some seal models. Metal bellows seals have special requirements and are commonly provided in Alloy C-276, Alloy 718, Alloy 316 and Alloy 400. The basic seal design and operating environment will determine which seal alloy should be used.

Industry Standards

There are several internationally recognized standards organizations which publish standards for mechanical seals and their related equipment. These include ISO, API, ASME and HI. Flowserve engineers are key technical contributors to these organizations and help define the future of the sealing industry. Flowserve can provide seals and systems in compliance with any of these sealing standards or specifications.



MECHANICAL SEAL PIPING PLANS

Flowserve recognizes that one of the most effective ways to achieve long, uninterrupted mechanical seal life is to create a healthy environment around the seal faces. Piping plans help keep mechanical seals running cool and clean, promote safe handling of dangerous fluids, and extend the operational availability of rotating equipment. The following pages provide a concise summary of the most essential piping plans used successfully in today's process plants.

Each plan shows all the standard and optional components referenced in API 682 and recommended by Flowserve. Consult your local Flowserve sales engineer to identify the right solution that satisfies your application requirements.

Good Piping Practices

Pipe size should be selected in relation to the seal size and cooling requirements. A minimum of 0.500 NPS should be used in general services and at least 0.750 NPS for API or heavy-duty seals. Pipe runs should be sloped for proper venting and draining, making sure the entire loop (including the seal gland) does not include vapor traps. Vertical pumps require special attention to achieve proper venting.

Piping should be as short as possible to avoid high pipe friction losses, especially with higher-viscosity barrier liquids such as oils. Sharp radius bends and gate valves in the loop must be avoided. The top of the seal gland should contain the flow outlet, while the inlet should be at the bottom or lower than the outlet.

Reference FTA160

Single Seals (Plan 23 shown)

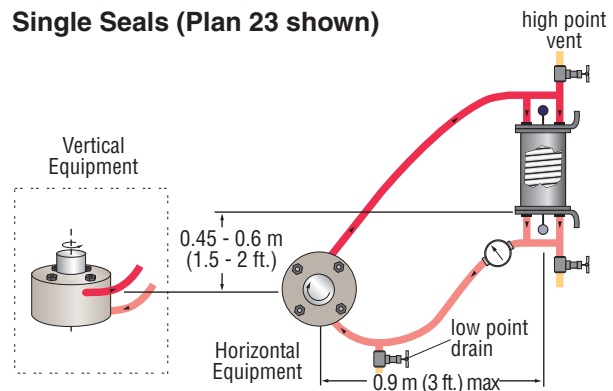

Dual Seals (Plan 53A shown)

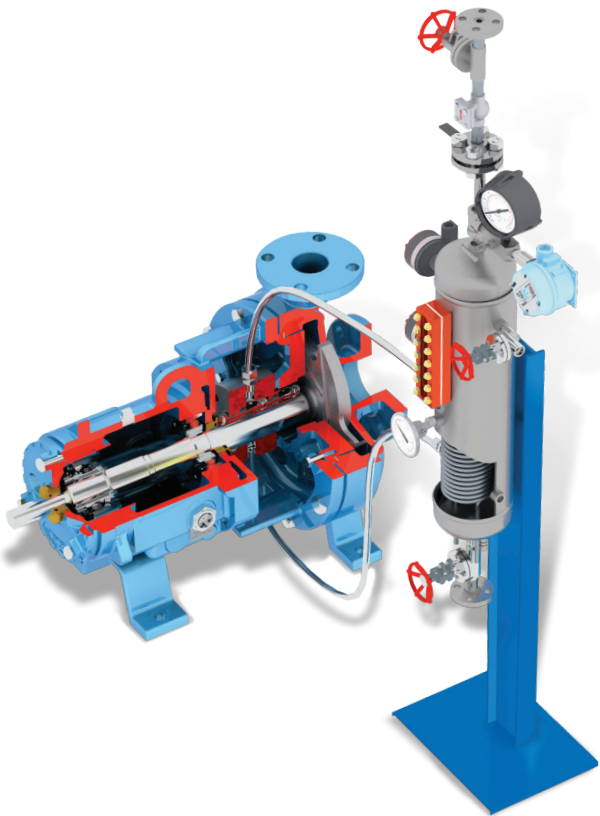
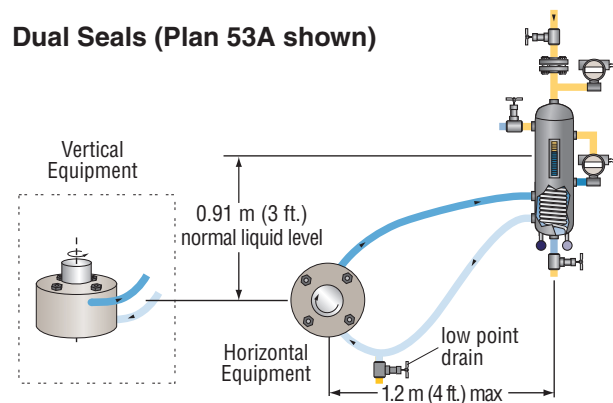

Plan 11

Seal flush from pump discharge through orifice.

Default single seal flush plan.

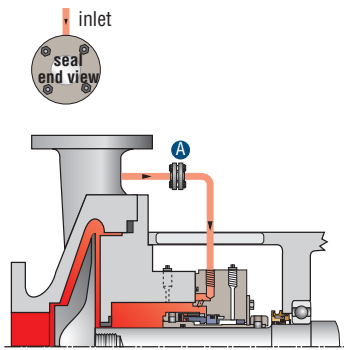

A - orifice

Plan 13

Recirculation from seal chamber to pump suction through orifice.

Standard flush plan on vertical pumps.

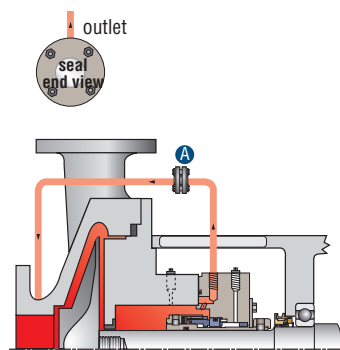

A - orifice

Plan 14

Seal flush from pump discharge and recirculation to pump suction with orifices.

Combination of Plan 11 and Plan 13.

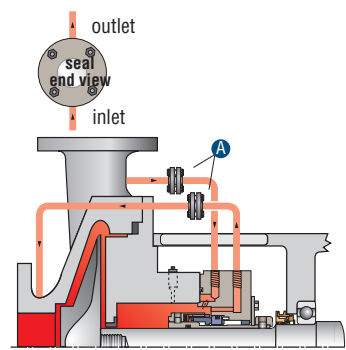

A - orifice

Plan 21

Seal flush from pump discharge through orifice and cooler.

Cooler added to Plan 11 flush increases heat removal.

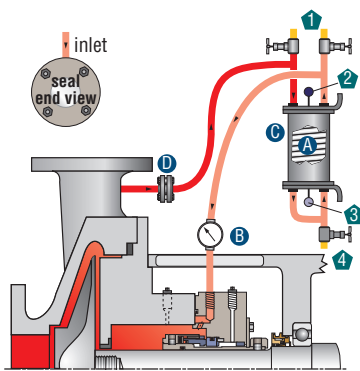

- A - cooling coils
- B - temperature indicator
- C - cooler
- D - orifice
- 1 - vents, normally closed
- 2 - cooling out
- 3 - cooling in
- 4 - drain, normally closed

Plan 23

Seal flush from internal pumping device through cooler.

Standard flush plan in hot water services.

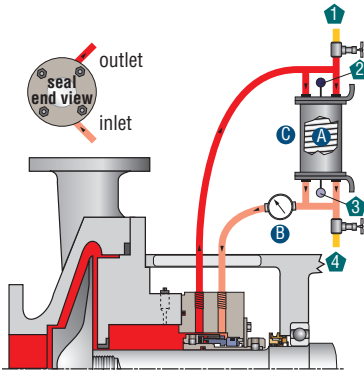

- A - cooling coils
- B - temperature indicator
- C - cooler
- 1 - vent, normally closed
- 2 - cooling out
- 3 - cooling in
- 4 - drain, normally closed

Plan 31

Seal flush from pump discharge through cyclone separator.

Centrifuged solids are returned to pump suction.

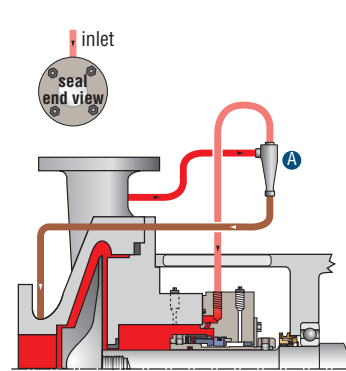

A - cyclone separator

Plan 32

Seal flush from an external clean source.

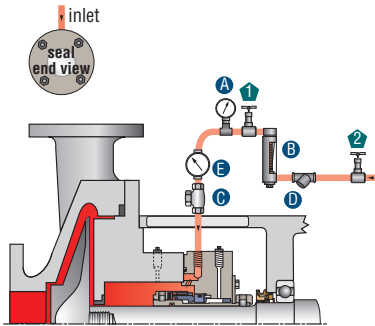

- | | |
|--------------------------------------|--------------------------------------|
| A - pressure indicator | 1 - flow control valve |
| B - flow indicator (optional) | 2 - from clean source, normally open |
| C - check valve | |
| D - strainer | |
| E - temperature indicator (optional) | |

Plan 52

Unpressurized buffer fluid circulation through reservoir.

Fluid is circulated by a pumping ring in the dual-seal assembly.

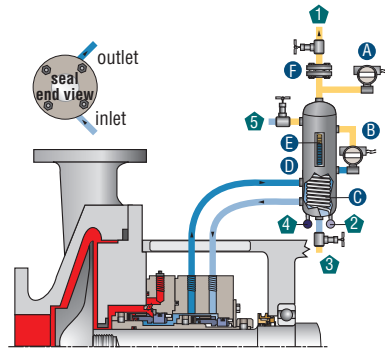

- | | |
|--------------------------|----------------------------------|
| A - pressure transmitter | 1 - vent, normally open |
| B - level transmitter | 2 - cooling in |
| C - cooling coils | 3 - drain, normally closed |
| D - reservoir | 4 - cooling out |
| E - level indicator | 5 - liquid fill, normally closed |
| F - orifice | |

Plan 53A

Pressurized barrier fluid circulation through reservoir.

Fluid is circulated by a pumping ring in the dual-seal assembly.

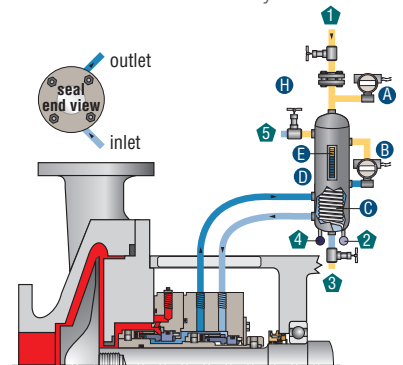

- | | |
|--------------------------|------------------------------------|
| A - pressure transmitter | 1 - pressure source, normally open |
| B - level transmitter | 2 - cooling in |
| C - cooling coils | 3 - drain, normally closed |
| D - reservoir | 4 - cooling out |
| E - level indicator | 5 - liquid fill, normally closed |
| F - reservoir | |
| G - level indicator | |

Plan 53B

Pressurized barrier fluid circulation with bladder accumulator.

Fluid is circulated by a pumping ring in the dual-seal assembly.

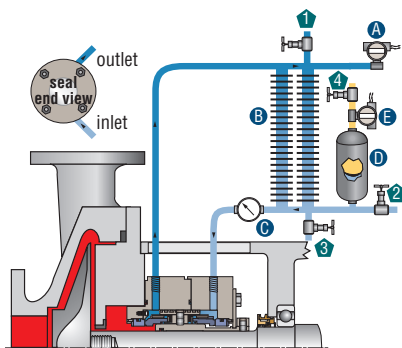

- | | |
|---|--------------------------------------|
| A - pressure transmitter | 1 - vent, normally closed |
| B - finned pipe (alternative reservoir) | 2 - liquid fill, normally closed |
| C - temperature indicator | 3 - drain, normally closed |
| D - bladder accumulator | 4 - pressure source, normally closed |
| E - temperature transmitter | |

Plan 53C

Pressurized barrier fluid circulation with piston accumulator.

Fluid is circulated by a pumping ring in the dual-seal assembly.

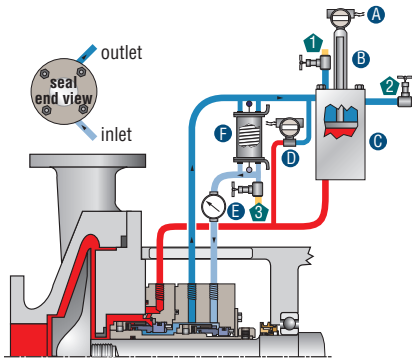

- | | |
|---------------------------------------|----------------------------------|
| A - level transmitter | 1 - vent, normally closed |
| B - level indicator | 2 - liquid fill, normally closed |
| C - piston accumulator | 3 - drain, normally closed |
| D - differential pressure transmitter | |
| E - temperature indicator (optional) | |
| F - cooler | |

Plans 54 and 55

Plan 54: Pressurized barrier fluid circulation by external system.

Plan 55: Unpressurized barrier fluid circulation by external system.

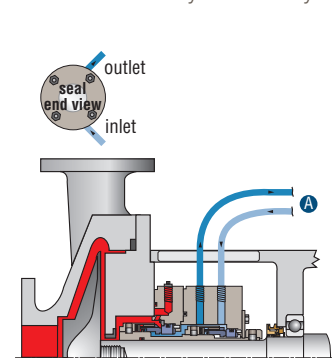

- | |
|---|
| A - from / to external circulating system |
|---|

Plan 62

External quench on atmospheric side of seal.

Quench fluids typically steam, nitrogen or water.

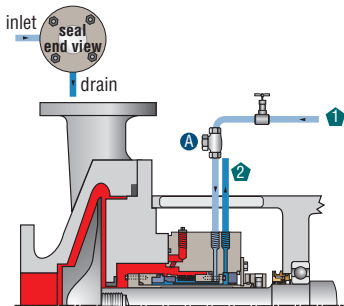

- A - check valve
- 1 - quench, normally open
- 2 - drain, see end view for proper orientation

Plan 65A

External drain with leakage detection on atmospheric side of seal.

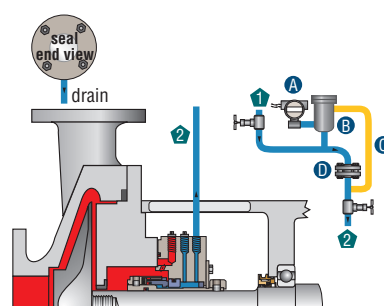

- A - level transmitter
- B - overflow chamber
- C - bypass line
- D - orifice
- 1 - block valve, normally open
- 2 - drain, normally open, see end view for proper orientation

Plan 72

Unpressurized buffer gas control system. Containment seal support typically with nitrogen buffer gas.

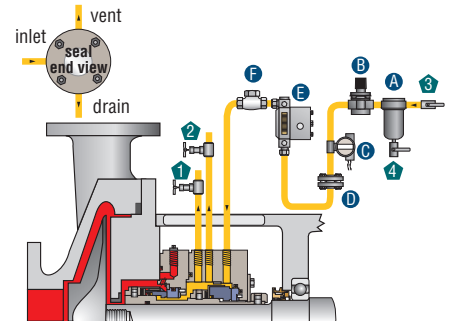

- A - coalescing filter
- B - regulator
- C - pressure indicator
- D - orifice
- E - flow transmitter
- F - check valve
- 1 - drain
- 2 - vent
- 3 - gas inlet, normally open
- 4 - filter drain, normally closed

Plan 74

Pressurized barrier gas control system. Gas seal support typically with nitrogen barrier gas.

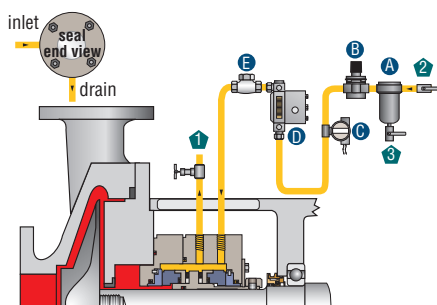

- A - coalescing filter
- B - regulator
- C - pressure transmitter
- D - flow transmitter
- E - check valve
- 1 - drain, normally closed
- 2 - gas inlet, normally open
- 3 - filter drain, normally closed

Plan 75

Drain from containment seal cavity to collector and vapor recovery.

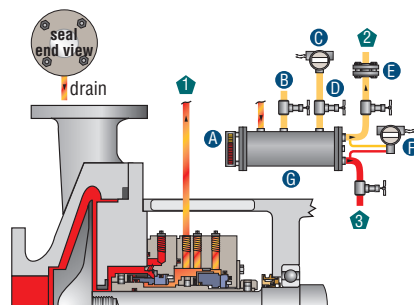

- A - level indicator
- B - test connection
- C - pressure transmitter
- D - isolation valve
- E - orifice
- F - level transmitter
- G - reservoir located below seal drain port
- 1 - drain, see end view for proper orientation
- 2 - vent, normally open
- 3 - drain, normally closed

Plan 76

Vent from containment seal cavity to vapor recovery.

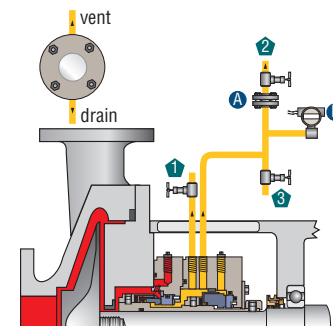

- A - orifice
- B - pressure transmitter
- 1 - drain, normally closed
- 2 - vent, normally open
- 3 - drain, normally closed



INDEX

Numbers

682 Water Seal Coolers 61

A

Airfin Seal Cooler 62

Allpac 47

Ampliflow 42

B

Bearing Gard 66

BGM 66

Bladder Accumulators 60

BRC and BRCSH 32

Buffer/Barrier Fluid Reservoirs 60

Buffer/Barrier Gas Panels 61

BulkTite 57

BX, BXQ and BXB 31

BXHHS and BXHHSB 31

BXLS 30

BXRH 31

C

Circpac CB, LO and HP 40

Circpac MD 56

Circulators 61

Cleanpac D, F and DL 41

CRO 24

Cyclone Separator 68

D

D and DP 27

Drypac 42

DuraClear 66

E

Europac Series 25

G

Gaspac T, L, D and S 40

GF-200 50

GLS 56

GSDH 51

GSG 56

GSL 50

GSS 55

GTS 55

GTSP 51

GX-200 50

H

HSH 26

I

ISC2 18

ISC2-682 18

ISC2-BB and ISC2-682BB 30

ISC2-BX, ISC2-XB,
ISC2-682BX and ISC2-682XB 30

ISC2-MW 18, 37

ISC2-PP and ISC2-682PP 23

ISC2-PX, ISC2-XP,
ISC2-682PX and ISC2-682XP 23

L

LS-300 55

M

Magnetic Separator 67

Mixerpac 36

M Series 36

MSS 37

N

N2 Genpac 42

P

Pac-Seal 54

Piston Accumulators 60

PL Series 54

PSS 4 54

Pusher Seals 21

Q

QB, QBS and QBU 23

QBB and QB2B 26

QBQ and QBQ LZ 26

R

RA and RA-C 25

Refill Cart 67

RIS 46

RO 24

S

Seal Gard 67

SLC Series 46

SLD 68

SLM Series 46

ST 37

Supplypac 41

T

Turbopac 378 and 2100 40

U

UC and UCQ 24

UHTW and DHTW 27

UO and UOP 27

V

VRA 36

W

Water Seal Cooler 62



Flowserve Corporation
5215 North O'Connor Blvd.
Suite 2300
Irving, Texas 75039-5421 USA
Telephone: +1 937 890 5839

Flowserve Corporation has established industry leadership in the design and manufacture of its products. When properly selected, this Flowserve product is designed to perform its intended function safely during its useful life. However, the purchaser or user of Flowserve products should be aware that Flowserve products might be used in numerous applications under a wide variety of industrial service conditions. Although Flowserve can provide general guidelines, it cannot provide specific data and warnings for all possible applications. The purchaser/user must therefore assume the ultimate responsibility for the proper sizing and selection, installation, operation, and maintenance of Flowserve products. The purchaser/user should read and understand the Installation Instructions included with the product, and train its employees and contractors in the safe use of Flowserve products in connection with the specific application.

While the information and specifications contained in this literature are believed to be accurate, they are supplied for informative purposes only and should not be considered certified or as a guarantee of satisfactory results by reliance thereon. Nothing contained herein is to be construed as a warranty or guarantee, express or implied, regarding any matter with respect to this product. Because Flowserve is continually improving and upgrading its product design, the specifications, dimensions and information contained herein are subject to change without notice. Should any question arise concerning these provisions, the purchaser/user should contact Flowserve Corporation at any one of its worldwide operations or offices.

©2018 Flowserve Corporation. All rights reserved. This document contains registered and unregistered trademarks of Flowserve Corporation. Other company, product, or service names may be trademarks or service marks of their respective companies.

FLS-1003 (E) April 2018